

CATALOGUE 2021

THE MOST  
INNOVATIVE  
IoT SOLUTION  
FOR SECURITY  
AND HOME &  
BUILDING  
AUTOMATION

**Ksenia**<sup>®</sup>  
security innovation



## ABOUT US

### RESEARCH & DEVELOPMENT

Ksenia Security is an Italian company active in the Security (Intrusion, Access Control and Video Surveillance) and Home & Building Automation fields. It develops and manufactures innovative solutions designed for residential, commercial and industrial markets. It combines a guaranteed cutting-edge technology with a high level of user-friendliness, paying particular attention to the design and eco-sustainability.

### PRODUCTION

The company develops and manufactures all its products in Italy, always following Italian quality and traditions. Every activity, from the design up to the final realization, take place directly in its workplace, creating a strong sense of belonging. It is a company constantly engaged in the search for innovations, with the mission of developing reliable certified devices through cutting edge technology. It achieves this by playing particular attention to the latest technological developments in the market, design and eco-sustainability.

### SALES

Ksenia Security has a wide distribution network, operating worldwide in 70 countries. It cooperates with the best partners in order to offer the best integrated solutions for the customers. Ksenia system is compatible with various third-party systems such as Google Home and Amazon Alexa voice assistants, Crestron and Control4 smart home solutions in addition to the integration with Konnex, Milestone, Nuance and much more.



**Ksenia**  
security  
[www.kseniasecurity.com](http://www.kseniasecurity.com)

# DON'T CALL IT JUST "ALARM SYSTEM"!

## ALWAYS CONNECTED

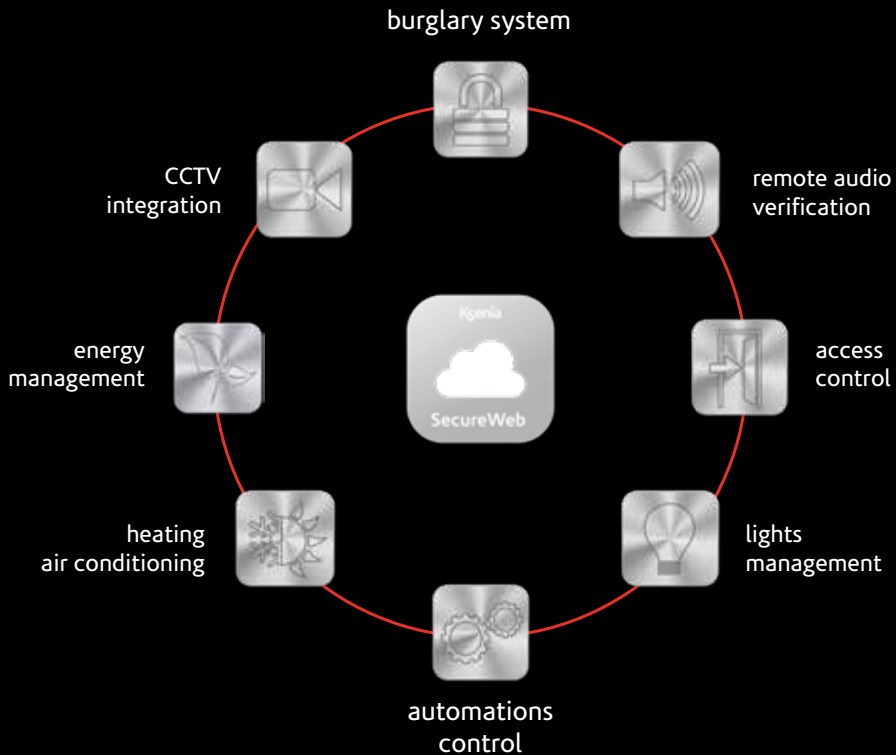

Guarda il video completo!



Watch the full video!

# Index

Our values	04
Hybrid IoT Control Panels for Security and Home & Building Automation <b>lares 4.0</b> and <b>lares 4.0 wls 96</b>	10
Smart Home Solutions	24
Communication Systems for <b>lares 4.0</b>	38
Wireless Technology	46
User interfaces	64
BUS Peripherals	74
Indoor and Outdoor Sirens	82
Wired sensors and detectors	88
Video-Surveillance and Video-Analysis Systems	96
Services for Installers	102

# Design



Ksenia Security pays special attention to product design. Through care for details, we choose a simple and minimalist profile, able to merge with any environment. At the same time, we don't neglect the functionality, offering accessible and intuitive solutions with advanced products representing a concentrated blend of simplicity, innovation and beauty.

04

# Innovation

Our mission is to create reliable products with great technological innovation. How do we do it? By listening to the needs of the market. Thanks to our R&D team, we commit to respond effectively to nowadays needs, focusing on originality and user-friendliness. This attitude is also expressed by our APP for Users and Installers which allow remote management and configuration, through an extremely intuitive interface and a surprising graphic customization.



# Made in Italy

Ksenia Security is deeply linked to Italian traditions and history. For this reason, we have decided to give latin names to our products. For us this is a way to provide recognition and affiliation. All our development, from design to final production, takes place in Italy.



05

# Eco-sustainability



Innovation and environmental respect: a winning combination. The new headquarters of Ksenia Security is a technological reality with low environmental impact independently producing renewable energy, independently, thanks to the photovoltaic system installed on the roof, contributing to a sustainable development consistent with one of our most important values: environmental sustainability. We have deep respect for human and workers' rights. We carefully evaluate each of our choices, from suppliers to the materials used, in order to reduce our impact on the environment.

we care



**INDUSTRY 4.0: MOBILE REVOLUTION**

**lares 4.0**

[www.kseniasecurity.com](http://www.kseniasecurity.com)





**The most Innovative IoT Solution  
for Security and  
Home & Building Automation**

# HYBRID IoT CONTROL PANELS FOR SECURITY AND HOME & BUILDING AUTOMATION

## lares 4.0



lares 4.0 .....	10
lares 4.0 wls 96 .....	11
User APP .....	14
Main functions .....	18
porta IoT .....	22
switch 4.0 .....	23



SCALABILITY



HYBRID SYSTEM



EASY TO INSTALL



EASY TO PROGRAM



REMOTE  
MANAGEMENT



5 YEARS  
WARRANTY



APPLICATIONS



INTEGRATIONS

# lares 4.0

product code KSI1400016.300 - lares 4.0 - 16  
 KSI1400040.300 - lares 4.0 - 40  
 KSI1410040.300 - lares 4.0 - 40 wls  
 KSI1410140.300 - lares 4.0 - 140 wls  
 KSI1410644.300 - lares 4.0 - 644 wls



lares 4.0 - 644+ wls



lares 4.0 - 16



lares 4.0 - 40



lares 4.0 - 40 wls



lares 4.0 - 140 wls



Secure web



App Ksenia Pro



App lares 4.0



5 years warranty

## CERTIFICATIONS

EAC  
 EN50131 Grade 3 - class II  
 T031:2017  
 SSF 1014 Larmklass 3



**lares deriva dal latino secondo cui i «Lari» nella Roma antica erano le divinità che proteggevano la domus, la casa; quale miglior nome per una famiglia di centrali di sicurezza?**

**lares comes from Latin and means "Lari": in Ancient Rome they were the divinities who protected the domus, the home. What better name for a family of Security control panels?**

The new lares 4.0 control panel is the perfect and most advanced solution in the age of digitalization (IoT), both for Security (Intrusion, Access Control and Video Surveillance) and Home & Building Automation.

All control panels are hybrid (both wired and wireless) and are provided with the same number of inputs and outputs, for lights, HVAC, irrigation, shutter blinds and any other kind of automation or household appliance, involving both Security and Home & Building Automation.

lares 4.0 is available in the following sizes: 16, 40, 96, 140 and 644 but, regardless of the chosen version, the motherboard comes with the Ethernet port already on board, an SD card slot, 8 input terminals + 2 configurable inputs or outputs and a 4G-LTE add-on module.

The control panel can be managed by the end-user through an App called lares 4.0 and can be programmed by the Installer via any mobile terminal, thanks to the Ksenia Pro App. Ksenia Pro App can also centralize and geo-locate all the control panels installed, offering the best assistance to the end user, by receiving push notifications.

## MAXIMUM RELIABILITY

The lares 4.0 control panel is designed to optimally take the strictest installation and management conditions and for the most "sensitive" applications. It is certified by the European standards EN50131 - Grade 3, supported by the quality marks IMQ (Italy), Incert (Belgium) and SBSC (Scandinavia).

# lares 4.0 wls 96

product code KSI1410096.30x - lares 4.0 wls 96 (polycarbonate box and power supply)  
KSI1414096.30x - lares 4.0 wls 96 (polycarbonate box, power supply and 4G module)  
KSI1414096.3xx - lares 4.0 wls 96 (polycarbonate box, power supply, keypad and 4G module)



lares 4.0 wls 96



## CERTIFICATIONS

EN50131 Grade 2 - class II  
T031:2017  
SSF 1014 Larmklass R



## HOW TO ORDER

**KSI1410096.301** - lares 4.0 wls 96

It is able to manage up to 96 zones, of which 40 wired and 18 outputs. It can be expandable with an KS-BUS: up to 3 user interfaces (to be chosen among ergo keyboard, volo and volo-in proximity readers), 1 BUS siren (imago or radius), 1 domus to manage the functions of the chronothermostat, 6 expansion modules (a choice among auxi and auxi-H), 2 among opis and divide.

IP peripherals management (ergo-T, gemino IoT, porta 4.0, cameras).

Provided with white polycarbonate box, integrated indoor siren,

25W power supply and a slot for 12V-2Ah lead-acid battery.

Dimensions: 297x220x55 mm. KSI1410096.302 with black polycarbonate box.

**KSI1414096.301** - lares 4.0 wls 96

Same features as the KSI1410096.301 but with the add-on 4G/LTE module. KSI1414096.302 with black polycarbonate box.

**KSI1414096.311** - lares 4.0 wls 96

Same features as the KSI1410096.301 but with ergo S soft-touch keypad integrated on the cover, add-on 4G/TE module. KSI1414096.322 with black polycarbonate box and integrated ergo S Keypad.

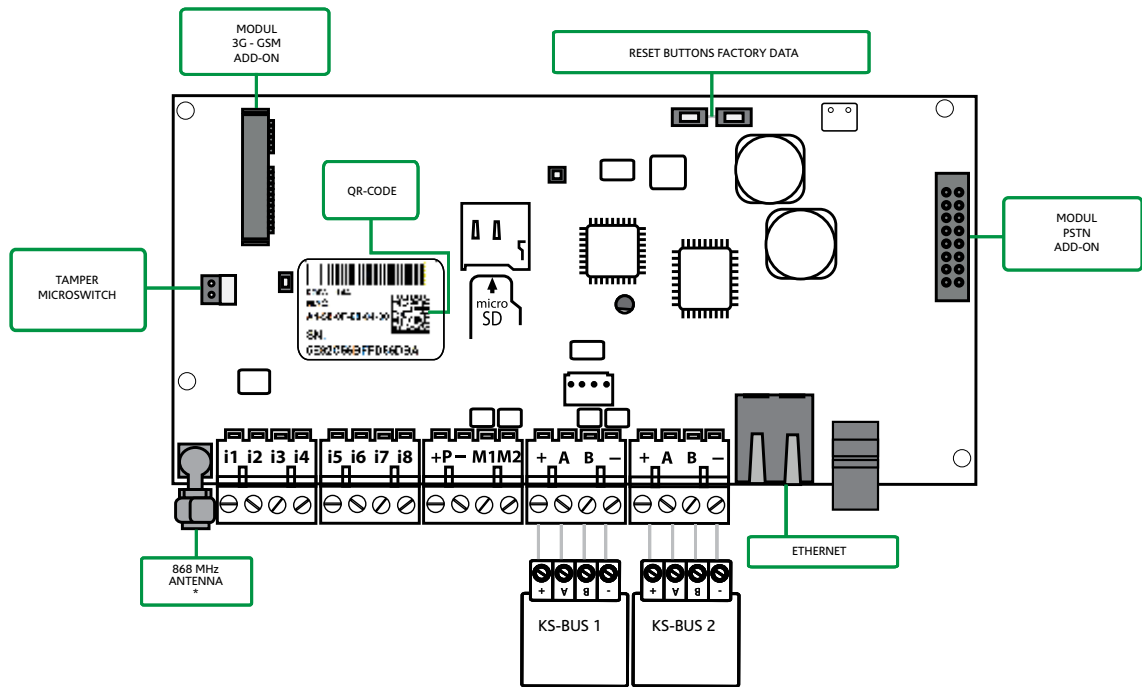

Certified  
EAC  
EN 50131- Grade 3 - class II  
and T031: 2017  
SSF 1014 Larmklass 3

## HOW TO ORDER

### KS11400016.300 - lares 4.0 - 16:

up to 16 IN + 16 OUT with 6 partitions - native with Ethernet interface.  
(no wireless on board - requires a duo transceiver)  
Dedicated APP for Installer (Ksenia Pro) and User (lares 4.0)

### KS11400040.300 - lares 4.0 - 40

up to 40 IN + 40 OUT with 12 partitions - native with Ethernet interface.  
(no wireless on board - requires a duo transceiver)  
Dedicated APP for Installer (Ksenia Pro) and User (lares 4.0)

### KS11410040.300 - lares 4.0 - 40 wls

up to 40 IN + 40 OUT with 12 partitions  
native with Ethernet interface and 868 MHz bidirectional wireless  
(DPMS technology - Dynamic Power Management System) and double  
BUS on board.  
Dedicated APP for Installer (Ksenia Pro) and User (lares 4.0)

### KS11410140.300 - lares 4.0 - 140 wls

up to 140 IN + 140 OUT with 20 partitions  
native with Ethernet interface and 868 MHz bidirectional wireless  
(DPMS technology - Dynamic Power Management System) and double  
BUS on board.  
Dedicated APP for Installer (Ksenia Pro) and User (lares 4.0)

### KS11410644.300 - lares 4.0 - 644 wls

up to 644 IN + 644 OUT with 30 partitions (and beyond on specific  
project): native with Ethernet interface and 868 MHz bidirectional  
wireless (DPMS technology - Dynamic Power Management System) and  
double BUS on board.  
Dedicated APP for Installer (Ksenia Pro) and User (lares 4.0)

(+) lares 4.0 - 644\* wls: In order to obtain a unique and customized solution, for large  
project, it is possible to agree a customization of  
lares 4.0 with a number of zones larger than 644 already available.

## PARTS INCLUDED

Each PCBA control panel board is provided with:

- Power supply cable and battery connection
- 10KΩ end-of-line resistors
- Installation manual and quick guide
- 868 MHz antenna with 30cm of cable (only on wls versions)

## ACCESSORIES

**KS17404130.010** - Metal cabinet painted in white 325 × 435 × 90 mm,  
lockable door and microswitch tampers, removable base,  
space for 7 expansion modules and an 18 Ah back-up battery.  
As standard, the metal cabinet is supplied with a 50W  
Switching power supply.

**KS17402117.010** - Metal cabinet painted in white 255×295×85 mm,  
lockable door and microswitch tampers, 2 keys, space for 1  
expansion modules and 7Ah back-up battery.  
As standard, the metal cabinet is supplied with a 25W  
Switching power supply

**KS17403130.010** - Metal cabinet painted in white 325×400×90 mm,  
lockable door and microswitch tampers, 2 keys, space for 2  
expansion modules and 7Ah back-up battery.  
As standard, the metal cabinet is supplied with a 50W  
Switching power supply

lares 4.0 performances

	lares 4.0 wls 96	lares 4.0 - 16	lares 4.0 - 40	lares 4.0 - 40 wls	lares 4.0 - 140 wls	lares 4.0 - 644+
<b>Zones management</b>						
Number of Zones (of wich radio)	96 (96)	16 (16)	40 (40)	40 (40)	140 (64)	644 (64)
Number of wired Zones	40	16	40	40	140	644
Support for IP Zones	●	●	●	●	●	●
Custom EOL Balances	1	2	4	4	14	64
Number of Outputs (of which radio)	18 (16)	16 (16)	40 (40)	40 (40)	140 (128)	644 (128)
Virtual Outputs (timer)	●	●	●	●	●	●
<b>On board features</b>						
I/O terminal	2 (Out only)	2	2	2	2	2
Inputs	4	8	8	8	8	8
868MHz radio interface	●	-	-	●	●	●
BUS interface	1	1	1	2	2	2
Indoor Siren Connector	●	-	-	-	-	-
Partitions	5	6	12	12	20	30
Arming Modes	8	8	32	32	64	128
Hashtags	2	2	12	12	20	64
Rooms	8	12	24	48	64	128
Timer for Scheduler	4	8	64	64	64	128
Event log	1500	1500	1500	5000	10000	10000
Number of users	16	16	64	128	512	1024
Programmable Logics	32	8	16	24	40	64
Chrono-thermostats	1	0	8	8	24	40
Meters (energia)	2	0	3	6	12	18
<b>Scenarios and Notification</b>						
Scenarios	8	8	32	32	128	512
Configurable event groups for scenarios/actions	32	32	64	64	256	1024
Contact Lists	8	8	8	8	16	32
Contact ID receivers (pairs)	1	1	3	3	3	3
SIA receivers (pairs)	1	1	3	3	3	3
Configurable event groups for Notifications	16	16	32	32	64	128
<b>IP Expandability</b>						
IP Cameras	4	4	12	12	20	30
ergo-T/ergo-T plus	1	2	4	4	8	14
gemino IoT	1	1	1	1	1	1
porta 4.0/porta IoT	1	1	1	1	1	1
IP Supervisors (Control 4 and Crestron integration)	1	1	1	1	1	1
<b>BUS Expandability</b>						
User interfaces (ergo; ergo-S/M; volo; volo-in)	3	6	24	24	40	64
I/O modules (auxi; auxi-10; auxi-R; auxi-H; auxi-L)	6*	4**	24	24	64	200
Single expansion (matrix BUS)	4	8	40	40	40	64
Sirens (radius, imago)	1	6	24	24	40	64
Isolators (divide, opis)	2	4	12	12	20	32
Transceivers (duo)	0	2	2	1 (2***)	1 (2***)	1 (2***)
Home automation sensors (domus)	1	0	8	8	32	64
Load controllers (energia)	1	0	1	3	6	6
<b>Wireless Expandability</b>						
Sensors (poli, nanus, unum, nebula, velum, matrix)	32	16	40	40	64	64
I/O module (auxi wls)	8	8	20	20	64	64
Sirens (imago wls)	3	3	3	3	5	5
Repeaters (duo)	2	2	2	2	2	2
Keypads (ergo wls)	4	2	3	3	4	4
Remote controls (opera)	16	16	64	64	64	64

\* Supports only auxi and auxi-H

\*\* Does not support auxi-H

\*\*\* Second BUS receivers can be used disabling on board Transceiver

# lares 4.0 User APP



## MAXIMUM FREEDOM and CREATIVITY

Thanks to this new APP, the User can manage all lares 4.0, wired and hybrids. The application allows the complete monitoring of the system, the management of the Home Automation part and all aspects of Video Verification, by connecting to any camera model able to make snapshots.

The interface is simple and intuitive. It is identified by a dashboard with temperatures and weather forecasts, usable through a new scrolling navigation. It allows the personalization by the User through the use of the favorites and the choice of the background color.

The APP lares 4.0 is divided into three sections: Dashboard, Security and Smart Home.

The status of the whole system is visible in the Dashboard and there is a quick check of the activation, or deactivation, of the alarm system.

In the Security section, it is possible to view the event logs and the status of all the sensors, manage the time programmer, view the details of any faults and access the user management and see the live-view camera mode.

The third and final section is completely dedicated to the Home Automation part: on this page the User can control all the exits, sorted by categories and have full control of lights, blinds, scenarios, and much more. The application is extremely flexible and allows you to set the page display even for the rooms; this facilitates the programming and the detailed view of the whole system.

The App lares 4.0 is free and available for iOS and Android operating systems, downloadable from the relevant stores on any mobile device, smartphone or tablet.





## Dashboard

The dashboard is the main page of the App, positioned in the central section.

It contains: the name of the control panel, the Info section with all the contact details of the Installer, the detected temperatures, the location name where the control panel is installed, an icon representing the weather of that specific location and, finally, your favorites.

At first glance, it is immediately possible to highlight the status of the system, thanks to the icon positioned in the middle of the dashboard: the status can be totally armed, disarmed, partially armed or in alarm. Each state is distinguished by a specific color: red, green or blue.

Finally, by clicking on the system status icon, the partitions page opens and you can control their status and arming them manually and individually, without using the scenarios.

## Acquisition of control panel

The acquisition of the control panel in the App is required after download. You have to enter name and serial number of the control panel, scan the QR code via the camera or edit the serial number. As an option there is the possibility to insert IP address, listening port and manage the type of connection but, if not provided, the connection will take place via Ksenia SecureWeb as well.

Dial your PIN code to enter the App lars 4.0 and start to manage your control panel.

## Disarm, arm and partial arm

From the Dashboard, three big colored icons immediately highlight the status of the system, click on them to arm or disarm the system, totally or partially. Total arming is only for partitions programmed to be totally armed, with or without entry/exit delay; the disarming can be total or partial; the partial arming only arms some partitions, with or without entry/exit delay. You can have multiple scenarios configured to arm the system and, in that case, you can select only the desired one from a list. Finally, by clicking on the system status icon, you enter the partitions page where you can control their status and arming them manually and individually, without using the scenarios.

## Geolocation and weather

On the left side of the Dashboard, you can read the detected temperatures (indoor and outdoor) by sirens, keypads and **domus** sensors, and on the right side you can read the location name where the control panel is installed and view an icon representing the weather of that location.

## Favourites

In the Dashboard there is a section dedicated to favorites, that is, all the most used features that the user wishes to always have at hand. You can

associate up to three favorites from smartphone and up to six favorites from tablet. To select a new favorite element, simply search for it in the App, press the icon and click on the star.

## 'Info' Section

In the Info section on the Dashboard of the App, you can view the complete profile of your Installer: telephone number, email address, company and logo.

**It is so important to quickly access all the contact details of your certified Installer when you are in troubles and need a prompt support!**

## Voice Assistants

From Panel settings page, it is possible to enable the integration procedure for Voice Assistants (Amazon Alexa and Google Home) and then choose between a Google or Amazon account by entering the appropriate credentials. At this point the control panel will be connected to the account and the last step required is the configuration of Google Home or Amazon Alexa App. After that, all the Smart Home devices installed can be managed only by using the voice commands: lights, roller blinds, scenarios, air conditioning and all the desired automations.

## Choice of theme

Possibility to customize the colour interface of lars 4.0 App (light or dark).



By default, the theme is light but, by enabling the Dark theme option, the App will take a dark grey theme. To make this change from the Dashboard, click on the Panel Settings icon.

## Security

From the Security section you can control the **status of sensors** installed (in idle, in alarm, fault/tamper) with the possibility of including, excluding and adding to favorites; **the status of the partitions** with possibility of arming/disarming them individually, in order to arm some customized actions, different from those programmed by the installer. Also the **time scheduler** is available in the Security section, it allows the creation of smart scenarios that can run according to a scheduler; the **events** to view the logs of the control panel where all the operations of the control panel are recorded; **cameras** to control accesses; system management for maintenance of faults and tamper; **users management** depending on the access level configured.

## Scheduler time

From Security page it is possible to open the Time Scheduler: Master users can program the automatic processes (represented by scenarios) which can be executed according to timetable and weekdays. Possibility of choosing the run time among "hour and

minutes", "sunrise" or "sunset". The sunrise and sunset values are calculated according to the geographic position (latitude and longitude configured) and the time zone where the Iares 4.0 control panel is installed. In this way, you can just select "sunset" to start lawn irrigation or turning on the outdoor lights, for example, without specifying a time; it will be the control panel that will run the scenario at sunset for that period of the year in that specific timezone. The holidays calendar of the country where the control panel is installed, is a valid aid in the configuration of the weekdays. The weekdays can be distinguished from the holidays so that, a disarm time scheduler, programmed every day at 07:00am (for example), will not take place if a holiday falls on a weekday.

## Cameras and Events log

In the Security section, the Events page allows to view the logs details of the control panels indicating date, type, description of the event and the name of the user who generated it. When an alarm, tamper or masking of a sensor occurs, the IP cameras (if installed) capture the images of the event occurred, to verify what happened. And more, you can open the Camera page to display their live images (one at a time), both locally and remotely.

## Counters

"Counters" function is a real time people counter to know how many people pass through a

security barrier or through one of our curtain motion detectors installed on the entrance/exit doors, but also by reading the Tag when passing through one of our proximity readers.

The counters can be incremented, decremented or set to zero according to the personalized actions that can be performed directly from the scenarios. In real time, it is possible to view the number of people present in a room; measure the flow of people who frequent a shop daily; authorize or not entry to gyms, cinemas, swimming pools, etc. Counters function can be monitored from Iares 4.0 App or ergo-T / ergo-T plus keypads, in addition to receiving notifications when a maximum programmable threshold is reached.

## Users management

In the Security section, the Users Management page allows to enable/disable tags, remote controls, codes, etc. of users, depending on the authorized access level. For example, by dialling a Master user PIN, it is possible to fully enable or disable a user or just some of his tools for managing the system, such as PIN, Tag and Remote Control; also, it is possible to change his name and his PIN code which must always be of six digits.

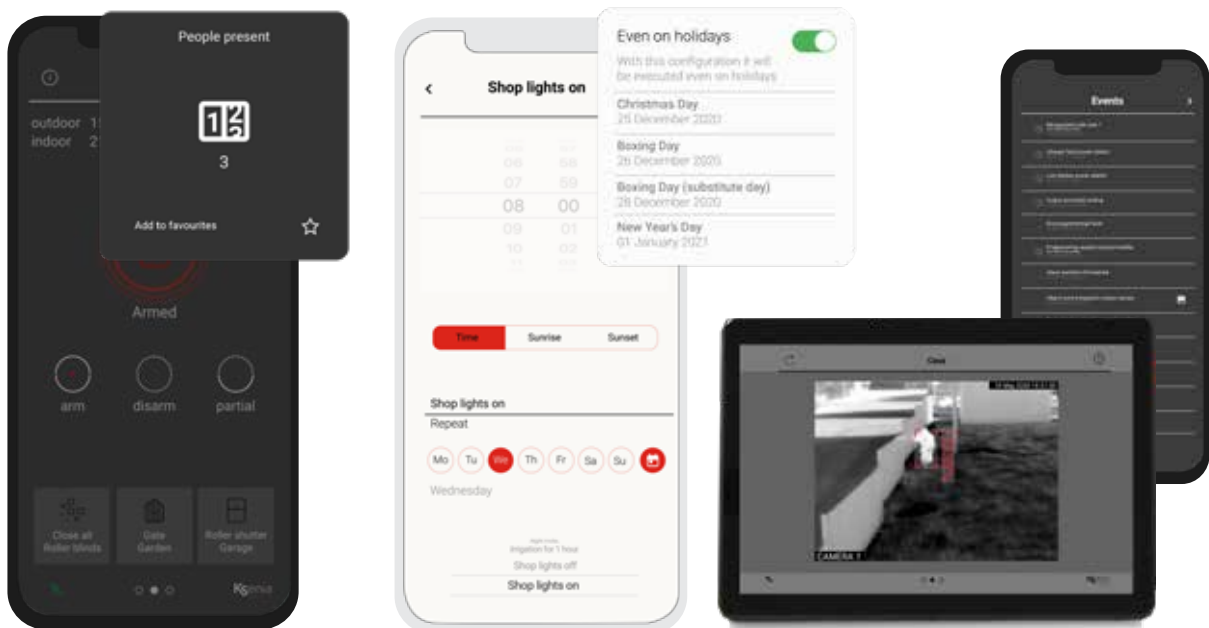

**Domotics**

In the Smart Home section it is possible to **control the automations** enabled for remote management, grouped by categories: lights (turn on/off, dimmer), opening gates (open/close), roller blinds (raise/lower/stop), etc., **manage the scenarios** programmed by the installer (management of outputs such as: "Turn ON the light", "Turn OFF the light", etc.; view and **adjust the temperature and humidity** detected by **domus** multisensors and **program the chronothermostat** (heating, air conditioning, schedules, weekly programs, etc.), add devices to favorites. The display of devices list is available in two modes: by category, where the sensors, outputs, scenarios and chronothermostats are grouped according to the category set by the installer, assuming their characteristic icon; by rooms, where they are grouped according to the rooms where they have been installed.

**Chronothermostat & functionality of domus**

Through the **domus** module, which can be installed in any environment, it is possible to manage the chronothermostat to gradually adjust temperature and humidity, thus improving the environment comfort level. Open the chronothermostat page from Smart Home section, that offers many

different operating modes: manual, timed manual, weekly, special 1, special 2 or OFF.

In addition, you can choose between "summer" or "winter" setting mode and the temperature throughout the day.

**Home consumption management**

The **energia** BUS peripheral is a module for energy loads management. It allows to manage the power used in your single-phase electrical system, on each of its two lines. **energia** module provides two distinct power lines on which measuring both voltage and current. When two programmed thresholds exceed, some push notifications and ringing alarms will be activated: the first threshold notifies that the maximum consumption has been reached and if no action is taken, it detaches the loads according to the programmed sequence. Consumptions and appliances can be managed and monitored from the Smart Home section in real time.

**Scenarios**

From Smart Home page it is possible to manage the scenarios. Within a predefined number of scenarios, depending on the model of control panel installed, it is possible to easily choose the desired combination among the entire range of home automation devices installed, in order to obtain the combination of several actions,

with a single gesture. By clicking on a single button, therefore, a series of actions is performed simultaneously, such as: shutting the roller blinds, turning off all the lights and activating the alarm.

**Analog output and dimmer function**

One terminal (M5) of auxi expansion module, can be programmed as an analog output 0-10V to adjust the output voltage. The analog output can be connected to actuators with standard input 0-10V, for detecting the voltage variations (e.g. generic dimmers, fan coils, etc.). Programming the analog output of the auxi BUS peripheral as an Intensity regulator (DIMMER) to increase/decrease the luminous intensity of a light/lamp, besides turn it on and off. The end user can adjust the luminous intensity with a slide bar, also the colour intensity varies according to the selected percentage value: from 5 to 100% (step = 0.5V). The icon changes as the setting of the category programmed for the device changes. The intensity regulator can be managed by the end user from Iares 4.0 App and **ergo-T/ ergo-T plus** touchscreen keypads, besides the graphic maps, vocal assistants and can be monitored it in real time too.

Lights management

Roller blinds management



# Description of lares 4.0 main functions

## Input section

Each control panel has 8 programmable inputs and 2 terminals that can be configured as inputs or outputs. Furthermore, a special connector is available for connecting the protections against opening and removal of the control unit from the wall. Depending on the model, the number of inputs can be expanded up to a maximum of 644, using the various aux expansion modules, the ergo keypads for wired zones or wireless detectors. Each input is programmable according to one's own needs: no control panel on the market offers so much flexibility.

The IP zones represent a new mode of operation allowing you to trigger an alarm of one single zone through a device capable of generating an HTTP GET request. The revolution is in being able to use just one device to detect the movement of an intruder, activate an alarm and access the screenshots. In fact, configuring the IP zone with a camera, the latter sends an alarm signal every time it detects a movement. So, the camera acts as a detection sensor, triggers the alarm and provides images, showing the intrusion to the control panel.

This implementation also opens new important integration scenarios: IP zones, in fact, allow you to associate not only cameras, but also other devices able to send this type of signals.

## Output section

The number of outputs can be expanded up to a maximum of 644 by using the various aux expansion modules, the ergo keypads or the wireless modules auxi wls. Each output can be programmed according to the needs: polarity, mode, times, activations. Everything easily suits to any installation need.

## KS-BUS interface

All the panels have a KS-BUS interface for connecting Ksenia peripherals, which allow to expand the capabilities and functionalities of the control panel. In the wireless versions, the panels have a double BUS on board, the speed is doubled and isolation is also guaranteed even in case of severe failure of one of the two BUS.

## Communication add-on

The communication add-ons can be connected to the control panel board: one for the mobile part (GSM/GPRS or 4G/LTE), the other one for the PSTN part.

## Unlimited Memory

All the panels have a 4GB eMMC memory to save programming data, event logs, updated device firmware, screenshots of IP cameras.

## Power control

lares 4.0 monitors both the external power supply voltage and the battery voltage: periodically it checks its efficiency and alerts in case of problems. Moreover, in case of prolonged power failure, lares has a battery disconnection function to prevent deep

discharges: the control panel, before "auto-shutdown", performs all the necessary checks, stores the date and time of the event going in stand-by in security. In this case even the sirens will not sound, avoiding unnecessary disturbances. When the power returns, everything will be restored as before, including the status of the outputs!

## Ethernet connectivity

In compliance with Ksenia philosophy, the IP interface is already integrated in the motherboard: a solution that allows you to comfortably manage the control panel from anywhere in the world from any internet connection. It is possible to program the control panel, perform all the management operations available in the system through the integrated installer WEB-SERVER, connecting to the Ksenia SecureWeb cloud for the remote management and programming via mobile APP. The system is protected by a triple security: all remote operations require password entry, the data are sent over the network under encrypted protocol and finally it is possible to disable remote access at any time or limit its functionality. In addition the system is able to send e-mails, synchronize the clock via NTP protocol, manage a P2P connection with the DNS ksenia, send the events to the telecommunications centers via the SIA DC009 protocol and much more without the need for hardware or additional licenses. Finally, the network port is the best way to expand the functions of the control panel:



remote communication via the gemino IoT with 4G-LTE module, user control via ergo-T and ergo-T plus touchscreens, integration with third-party systems.

### ONVIF compatibility

On each version of the lares 4.0 control panels, cameras compatible with the ONVIF protocol (Open Network Video Interfaces Forum) can be integrated without the need for additional cards or hardware. Without the need to perform port mapping on the router, it is possible to send screenshots when an alarm occurs or see what happens in the protected areas in real time.

### Partitions

Each zone can be freely associated to a partition to simplify its management, depending on the model up to 30 partitions are available. For each partition it is possible to program the entry, exit, warning, patrol times and define different entry modes.

### Voice messages

On the control panel it is possible to register a virtually unlimited number of different voice messages, with hundreds of minutes of recording; they allow to warn the user in case of alarm or failure (with a personalized message for each zone).

The voice messages are generated by a text-to-speech (TTS) synthesis engine: it is available thanks to the Loquendo® libraries (\*) and released by a "one-off" license.

You can use the licenses purchased on USB key that are compatible with traditional lares, for the generation in local connection, or buy a new one with scratch card for generation via Ksenia SecureWeb (therefore remotely via APP).

### Programmable logics

Any request received from your Customer, even the most demanding ones, can be satisfied thanks to the Programmable logics.

Try to put together hundreds of different events and arrange them with AND/OR operators: it will take few seconds to make the features of lares 4.0 more flexible and surprising!

### #Hashtags

#hashtags are a necessary tool of work when you need to implement replicated programming. After all, they are simply labels which allow to operate on several homogeneous objects at the same time. So, to create a scenario to switch off all the lights, you do not need to program a long list of actions that should act on a single output. It will be enough to create #hashtag #light, associate it to all related outputs and write down just one instruction that turns off all the #light. The same facility is also available for zones, users and user interfaces management!

### Lots of new security features and integrated home automation

Not only is the platform easily integrated into any logic of Home Integration & Automation, but it is also the absolute protagonist being perfectly able to manage the home automation applications you have always dreamed of for your home without the need for PC or complicated programs.

Below is a list of some home automation applications that do not include intrusion:

- lighting
- heating / air conditioning systems
- irrigation systems
- automation and load control
- fire detection and suppression system
- audio and video entertainment
- audio and video surveillance
- access control

The control panel also allows the acquisition of a new programming without restarting the system, any modification does not change the status of the system.

New functions have been added to expand the potential of the control panel, such as hashtags per zones, outputs, users and user interfaces: a single label to manage even 644 outputs in one go! Many new features on scenarios, such as the possibility to exclude and include



#### HOW TO ORDER

**KSI7800011.000** - Scratch card with a licence for 1 voice/1 language. It can be activated on [www.kseniasecureweb.com](http://www.kseniasecureweb.com)

**KSI7800010.0xx** - License on USB hardware support with a licence for 1 voice/1 language. Contact Ksenia's sales office to select the voice / language.

**Loquendo**

\* It may be associated with any model / brand of Control Panel, even if they are without voice dialer.

zones, enable or disable users, manage 4 modes of entry (manual override, forced with exclusion, forced with alarm, certified EN50131). Moreover the behaviour of the scenario can even be variable depending on the localization (local or remote): for example, opening a door remotely requires the insertion of a PIN while locally it takes simply to press a button!

All this without losing control of the intrusion, today even more powerful but simplified in many aspects to facilitate the Installer's work.

### Access control

The access control section, already integrated on the lares 4.0, is also highly developed. In fact, the control panel is able to manage over 1000 users to whom it is possible to associate PINs to be used in the keypad or RF-ID tags. The user can interact with the system by having up to 64 user interfaces (keypads and proximity readers), which allow a management of every gate. Each user can be assigned to one of 7 different access levels, with different

privileges: from the administrator who has complete control of the system, to the minimum level which is only allowed to activate a scenario.

From lares 4.0 app it is possible, for administrators and masters users, to manage the authorizations and configurations of other users, as long as they belong to the same partitions.

### Rooms / Maps

Enduser has at his disposal a logical organization subdivided into rooms, so that he can interact with numerous features configured on his control panel. Each device that has been programmed on the system (sensors, outputs, scenarios, cameras, etc.), in fact, can be combined with one or more rooms. With the APP lares 4.0, opening the display for rooms in the section SMART HOME, it is possible to see each element, previously configured, in that room and be immediately in control wherever you are.

But there is more than that!

Each room can be linked with an image, a picture of the space or a layout where each device can be placed exactly where it is physically located.

With one simple click, through the user WebServer, you can move from one corner of your house to the other, without having to get up from your couch!

### Chronothermostats

Thanks to the temperature and humidity sensor of domus, the central panel offers to enduser a sophisticated control of heating and air-conditioning of rooms. Each control panel can manage up to 40 independent chronothermostats, each one of them can operate over independent air-conditioning devices or thermostatic valves. The easy management through APP lares 4.0 for user, or even from ergo-T touch keyboard, joins an exceptional level of functions: from a trivial manual management of temperature up to the programming of weekly programmes divided into time slots and advanced energy saving modes.

Of course, both heating and air-conditioning can be set according to the season.

Finally, the possibility of controlling humidity of environment, because 360 degree management of comfort is a must-have!

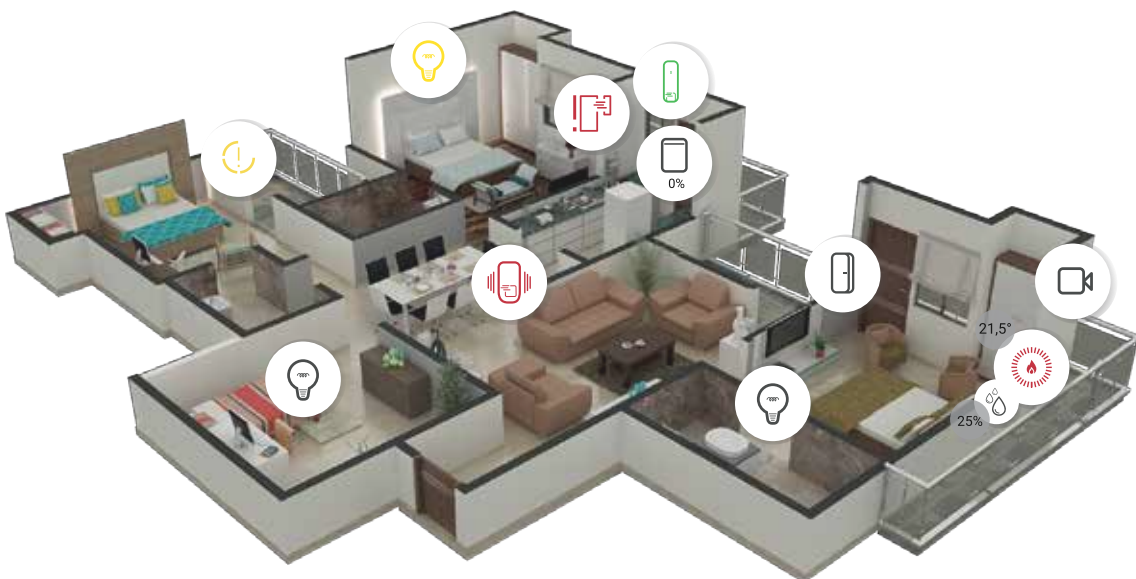

### Firmware update remotely

Both the control panel firmware and all the peripheral devices connected via the KS-BUS can be simply updated in a few seconds.

It is not necessary to make any special connections, nor to insert jumpers or switch off the system or peripherals: the firmware is already in the control panel which downloads it by itself at every update from the Ksenia SecureWeb.

The update is done by simply pressing a button and it is safe. All Ksenia Security devices have a unique firmware update technology: the dual-firmware-mode.

A copy of the new firmware is saved on the device (control panel) that needs to be updated. Once the copy is finished (it can be done during normal system operation) the

device checks the new firmware using a CRC (Cyclic-Redundancy-Check): if it is correct, it will start using the new firmware; otherwise it will continue to use the old code, ensuring maximum reliability even in case of interruption of the transmission.

In practice all Ksenia Security systems are backwards compatible, new features or functions available in the future can be added also to existing systems without the need to modify or replace the peripherals themselves.

### Future devices: scalability

This special update management ensures that, once a lares control panel is installed, it will be compatible with all future Ksenia Security devices, without any need to replace the control panel, simply by updating its firmware.

### The future ahead of us

lares 4.0 is an evolutionary platform that will allow us to always add new and innovative functions oriented to Security, access control and Home & Building Automation.

Feedbacks from our customers are important to give the right priorities to all the functions we intend to add from time to time and identify new ones.

lares platform has been constantly enriched with functions from 2011 until 2015, absorbing most of the R & D resources. We expect the lares 4.0 platform to follow the same path!



# porta IoT bidirectional http gateway

product code **KSI4300002.300** - porta IoT

22

HYBRID IoT CONTROL PANELS FOR SECURITY AND HOME & BUILDING AUTOMATION / porta IoT



http/s is one of the protocols allowing thousands of IoT devices to communicate with each other.

Through this protocol, it is actually possible to control and manage any system in a clear and efficient way: from straightforward client/server designs to complex and distributed network architectures.

porta IoT is a device designed to interface with lares 4.0 control panel family in a quick and easy way, without using, in most cases, SDK integrations. This is possible thanks to the http/s API exposed through porta IoT giving the chance for example to:

- include / exclude, alarm and restore the zones;
- manage monostable and bistable outputs;
- run a scenario;
- and much more by managing POST, PUT and GET requests.

At the same time, when an event happens, lares 4.0 control panel is able to send POST, PUT and GET requests compatible with the devices that you want to control, thanks to the porta IoT module.

Additionally, porta IoT boosts the security of the integration:

- By supervising the IP devices from which it accepts http / s requests;
- By requiring a specific token for APIs.

## TECHNICAL DATA

- Power Supply: 12 - 24VDC or PoE
- Consumption: 5W max
- Communication BUS: RS-485 (future use)
- Ethernet interface: RJ45
- Operating range: +5 to +40°C
- Dimensions: 86 x 69 x 58mm
- Weight: 130g

## HOW TO ORDER

- KSI4300002.300 - porta IoT Gateway

## ACCESSORIES

- KSI4400000.300 - switch 4.0

## PARTS INCLUDED

- 1 porta IoT Gateway
- 1 Installation manual

porta IoT ensure a full integration with the lares 4.0 control panel: all the configuration is accomplished on the control panel web interface. The device is connected to the control panel via Ethernet and can be powered both, via PoE and from an external power supply (12V).

porta IoT is provided with plastic box occupying 4 DIN slots.

## Perché porta IoT why porta IoT

- **because** it interfaces with the lares 4.0 control panel via http/s API, making integration with other devices much easier;
- **because** it increases the security with the integrations, (such as IP zones), by inputting supervision and tokens on each API;
- **because** no dedicated softwares or any other programming steps are need: the configuration is managed via lares 4.0 web interface.



# Switch 4.0 4 port LAN switch

product code KSI4400000.300 - Switch 4.0



switch 4.0 is a 10/100Mbit Ethernet network switch, designed to connect the Control Panels System lares 4.0 with our IP modules (ergo-T/ergo-T plus, gemino IoT, porta etc).

It has 4 Ethernet network ports, one of which is PoE (Power over Ethernet) that can be used to directly connect an IP module.

The device is powered directly from the lares 4.0 Control Panel power supply and therefore ensures a PoE power supply back-up to the IP modules.

## TECHNICAL DATA

- Supply: 13.8Vdc /1A max
- Switch 4 ports 10/100Mbit of which 1 PoE port 13W max
- Dimensions: 75x60x16mm

## PARTS INCLUDED

- 1 Switch 4.0 PCBA
- 4 Sustainers for PCBA
- 1 Installation manual

## HOW TO ORDER

- KSI4400000.300 - Switch 4.0

## CERTIFICATIONS

Europe - CE, RoHS

		lares 4.0	gemino IoT	Add-on 2G	Add-on 3G	Add-on 4G	Add-on PSTN	gemino 4 gemino exp.
		Mode of communications to the users	Vocal Messages		●	●	●	●
SMS			●	●	●	●		●
e-mail	●		●	●	●	●		●
Communication Standards to CMS/vigilo supervisor	Contact-ID (SIA DC-05)		●	●	●	●	●	●
	IP Protocols (SIA DC-09 Level III)	●	●	●	●	●		●
Remote Management Options	Arm/Disarm	APP, WebServer	APP/Vocal Menu (through scenario)	APP/Vocal Menu (through scenario)	APP/Vocal Menu (through scenario)	APP/Vocal Menu (through scenario)	Vocal Menu (through scenario)	
	Output management	APP, WebServer	APP/Vocal Menu (through scenario)	APP/Vocal Menu (through scenario)	APP/Vocal Menu (through scenario)	APP/Vocal Menu (through scenario)	Vocal Menu (through scenario)	Caller ID, SMS
	Video verification	●	●		●	●		
	Audio verification (listen-in)			●	●	●	●	
UP & Download	Programming Software (basis)							●
	SecureWeb	●	●	●	●	●		

# SMART HOME SOLUTIONS



domus.....	26
energia.....	28
auxi-H .....	30
auxi-L .....	32
auxi .....	33
auxi wls .....	34
porta 4.0.....	35
integrations .....	36



TEMPERATURE  
AND HUMIDITY  
DETECTION



PRESENCE  
DETECTION



COMFORT  
MANAGEMENT



DISCONNECTION  
OF LOAD



PROGRAMMING  
VIA SOFTWARE



ELECTRICAL  
LOADS  
MANAGEMENT



LIGHTING  
MANAGEMENT



INTEGRATIONS

# domus Multi-function sensor

product code **KS12700000.300** - domus

26

SMART HOME SOLUTIONS / domus



## TECHNICAL DATA

- Power Supply: 13,8 Vdc
- Consumption: 10mA max
- Temperature sensor ( $\pm 0,2$  °C)
- Humidity Sensor ( $\pm 2\%$  RH)
- PIR detector, 6 meters capacity, 5 rays, opening: 45°
- Light sensor
- Compatible with Keystone opening
- KS-BUS interface

## HOW TO ORDER

- KS12700000.300 - domus

## PARTS INCLUDED

- 1 domus Multi-function sensor
- 1 Quick Installation Guide ITA/EN

## COMPLIANCE

Europe - CE  
EAC



**domus** deriva dal latino e significa **casa, abitazione.**  
*domus derives from Latin and means home, house.*

**domus** is a built-in module which, like the RFID reader for volo-in access control, uses the Keystone slot (of identical size on any series of switch plates) to insert a new device that allows, for each room, to have in a single device a motion detector, a temperature sensor, relative humidity and light intensity. Ideal for home automation, in combination with auxi-L module, it allows to switch lights on and off depending on the internal brightness, whenever someone is in the room.

It also has a temperature and humidity sensor, produced by Sensirion (world leader in the production of these devices) and able to drive and manage at best its own air conditioning and dehumidification systems, in order to obtain the desired degree of comfort.

It becomes indispensable for office environments and for the standard humidification required in museums for the best conservation of art works.

domus is the ideal device for temperature control in the residential area and not only: it can be easily installed in any environment. Thanks to the chronothermostat available on lares 4.0 control panel, it is possible to adjust the temperature comfortably and anywhere, adapting the level of comfort to the use of the environment with significant energy savings. Thanks to the flexibility of lares 4.0 control panel it can control both heating and conditioning devices.

domus connects to lares 4.0 control panels via KS-BUS 4-wire serial BUS and is programmed directly from the control panel.



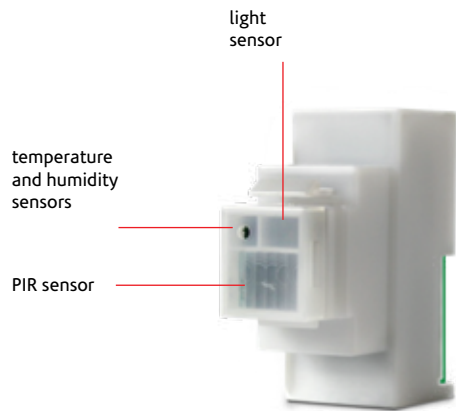

**Perché domus**  
*why domus*

- **because** in a single device there are 4 sensors, and this allows its use in the most various applications
- **because** thanks to its dimensions it occupies only one module of box 503
- **because**, thanks to its design, it fits into a keystone adapter, and it is therefore compatible with any electrical civil series
- **because** it has one of the best temperature and humidity sensors on the market; its positioning on the front of the device with a minimum opening also allows an accurate measurement of the real parameters of the environment
- **because** it connects quickly with the 4-wire BUS, and it is completely manageable by lares 4.0 control panel

COVERAGE AREA

TOP VIEW

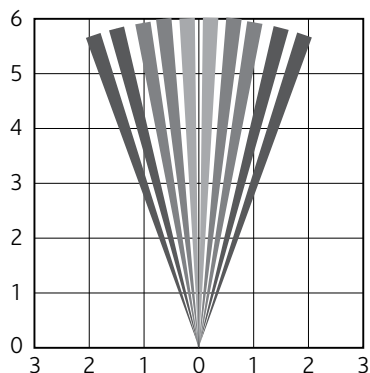

SIDE VIEW

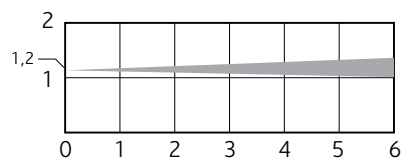

# energia consumption management system

product code **KSIZ700001.300** - energia module

28

SMART HOME SOLUTIONS / energia



## we care



**energia deriva dal latino e significa energia.**  
*energia derives from Latin and means energy.*

Enhancing the market awareness about the benefits of **sustainable energy**, it is the stated goal of current government regulations. **energia** module produced by Ksenia Security for energy sector, fully meets this project in terms of **electric load management**, including renewable sources, and control and balancing of **power consumptions**.

Each **energia** module provides two distinct power lines on which measuring both voltage and current, each line can support loads up to 6kW.

The values of the voltage of the two lines expressed in Volts and the current measured on each line L1 and L2 expressed in Ampere, measured in one tenths of Ampere, are displayed in real time. The maximum configuration number of the energia module depends on the lares 4.0 control panel models:

• lares 4.0 wls 96	n. 1
• lares 4.0 16	-
• lares 4.0 40	n. 1
• lares 4.0 40 wls	n. 3
• lares 4.0 140 wls	n. 6
• lares 4.0 644 wls	n. 6

**energia** module must be linked to the lares 4.0 control panel via the KS-BUS. It becomes the ideal complement when lares 4.0 is used in the home & building automation field.

## TECHNICAL DATA

- **Maximum power:** 2x6kW
- **4 relays outputs:** 250 V - 1 A
- **KS-BUS Interface**
- **Dimensions:** 90x53x62 mm (hxlxp)

## INCLUDED PARTS

- 1 energia module
- 1 Installation guide

## HOW TO ORDER

- **KSIZ700001.300** - energia module

## COMPLIANCE

Europe - CE  
EAC



**Power consumption management** is implemented starting from the data collected by **energia** module. Subsequently, an application logic processes the data collected, structures and stores them and finally shows the result of energy consumption trends to the users, in the form of bar charts. The configuration of entities called "**meters**" are mandatory to make the application logic work properly. They measure the power absorbed or produced, for example in the presence of a photovoltaic system, by L1 and L2 lines of energia modules available in the system, in real time..

The configuration of the "**meters**" is preparatory to obtain useful charts for the analysis of power consumption. For example, in the presence of a photovoltaic system, if there are two **energia** modules in the lares 4.0 platform, we can configure three "**meters**": one for measuring the absorbed power (i.e. Consumption), one for the produced power (i.e. Photovoltaic production) and one for displaying both powers (i.e. Energy balance), obtaining the following bar charts.

The charts show the historical consumptions, allow the analysis of the power consumption trend, with the aim of identifying potential waste and optimize energy consumption.

The collected data are processed, encoded, and displayed in bar charts for an immediate understanding of the consumption trend, comparing the power produced and the power absorbed. All this allows to identify the appropriate interventions to avoid inefficiencies and contribute to achieve **Energy Efficiency**.

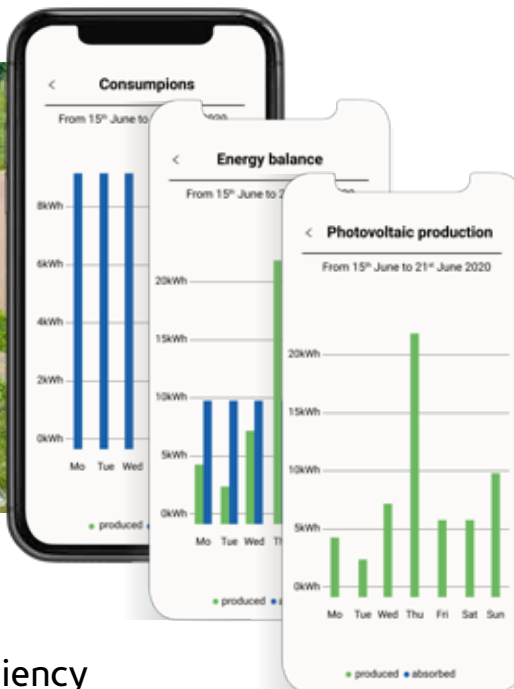

## Analysis of the power consumption trend

## Energy Efficiency

The value of the power in real time, positive or negative, is displayed for each meter (power absorbed is blue, power produced is green). The “meters” can be associated to partitions and rooms and displayed in the lares 4.0 user App, also the charts can be displayed in the App. In the context of **Load Management**, the “meter” carries out the controlled disconnection of loads to avoid blackouts when the electric system is getting overloaded.

Each “meter” provides two thresholds:

1. Maximum power consumption threshold expressed in Watts, beyond this value an alert is generated (ergo-T and ergo-T plus keypads also offer sound and push notifications);
2. Maximum power disconnection threshold (greater than the previous one), beyond this value the loads disconnection starts.

The outputs personalized as “Manageable load” in the lares 4.0 control panel can be disconnected. According to the control panel model, the maximum number of outputs configurable are:

- no. 8 lares 4.0 644 wls and lares 4.0 140 wls;
- no. 4 all the other models (except lares 4.0 - 16).

The configured outputs (washing machine, dishwasher, oven, etc.) are visible in real-time as connected/disconnected household appliances, on the Smart Home page of the lares 4.0 App, in the “Household appliances” category and on Maps.

### Perché energia why energia

- **because** it has the requirements to respond to requests for energy efficiency enhancement;
- **because** it can measure and manage the power consumption on each of its two lines, each line can support loads up to 6kW;
- **because** it can control the power consumption trend through displaying bar charts for an immediate analysis;
- **because** it can program the disconnection of loads after exceeding two thresholds (the first sends push and sound notifications, the second starts disconnection);
- **because** it can control the status of household appliances in real time (connected/disconnected) from lares 4.0 App and Maps;
- **because** it is provided with 4 free configurable outputs relays;
- **because** it can be linked to the control panel via the KS-BUS, quickly and easily.

# auxi-H Expansion module

product code **KS12300005.300** - auxi-H PCBA

30

SMART HOME SOLUTIONS / auxi-H



## TECHNICAL DATA

- Up to 2 inter-locked relays output 250V-8A
- Up to 3 alarm input
- 2 input for local buttons
- Up to 6 different positions for the roller shutter
- Compact size: 45x75x16 mm
- Plastic box for installation on DIN guide
- Fast Addressing System on KS-BUS

## PARTS INCLUDED

- 1 auxi-H expansion module (PCBA)
- 4 sustainers for metal or plastic cabinet's
- 1 Installation Manual

## HOW TO ORDER

- KS12300005.300 - PCBA auxi-H

## ACCESSORIES

- KS17300000.001 - Plastic box for DIN rail

## COMPLIANCE

Europe - CE  
EAC



**auxi** deriva dal latino e significa **crescere, aumentare, potenziare**.  
**auxi** derives from Latin and means to **increase, to potentiate**.

**perché auxi-H**  
**why auxi-H**

**auxi-H** is a module that can be used both for security and home automation. Thanks to a special jumper on the board, it is possible to set two operating modes:

1. **auxi-HT**: in this mode the device is designed for the full management of windows equipped with motorized roller shutters;
2. **auxi-HL**: in this mode the device is designed to manage lights.

In the first case (**auxi-HT**), the 2 relay outputs (8A-250V) become interlocked to control directly the roller shutter motor. From the scenarios configured on lares 4.0 it is possible to completely open and close the rolling shutters.

With the local buttons it is possible to open/close shutters in step by step mode or open/close them automatically with the hold-to-run feature.

In the second case (**auxi-HL**), the two relay outputs can be both freely controlled by the scenarios of lares 4.0 and managed locally by connecting the buttons to the local inputs. In fact, in both operating modes, there are 2 freely configurable inputs and an alarm input connectable to the shutter sensors. Like all Ksenia Security expansion modules, it is extremely compact in size (only 70x45mm), allowing space savings. It can be placed both inside DIN-503 boxes and on DIN rail, with a considerable reduction of installation time.

**auxi-H** connects to the lares 4.0 control panels with the 4-wire KS-BUS serial BUS.

- **because** with a single device it is possible to completely control any spot equipped with motorized roller shutters. It is able to control the motors, move the roller shutters, even when the system is armed and without the need to disarm it + one of the inputs can be configured to block the movement of the roller shutter (for example with the installation of a photocell);
- **because** it does not give the opportunity to just open and close roller-shutters: it is also capable to set them in intermediate positions;
- **because** it allows remote checks of the shutters opening status;
- **because** it is flexible and adapts its feature for the management of roller shutters or lights through a simple jumper;
- **because** the local buttons continue to work even in the event of a control panel failure.





## Roller Blinds Management

## Lights Management

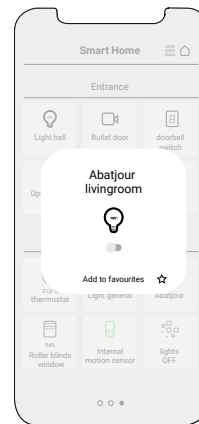
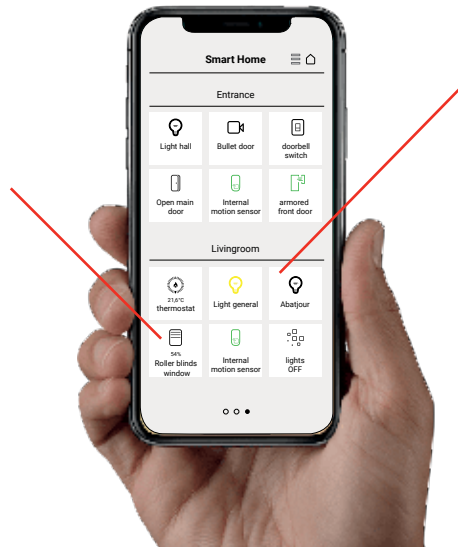
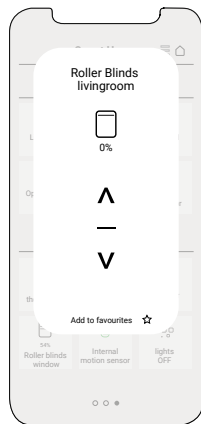

# auxi-L Expansion module

product code **KS12300004.300** - auxi-L PCBA

32

SMART HOME SOLUTIONS / auxi-L



## TECHNICAL DATA

- **Power Supply:** 13,8 Vdc
- **Consumption:** 120 mA max.
- **Output:** Up to 5 relay, 250 V - 8 A (10 A peak)
- **Fast addressing System** on KS-BUS
- **PCB Dimension:** 45x75x16 mm

## HOW TO ORDER

- **KS12300004.300** - auxi-L PCBA

## ACCESSORIES

- **KS17300000.001** - Plastic box for DIN rail
- **KS17302000.010** - Plastic box "slim" version

## PARTS INCLUDED

- 1 auxi-L expansion module (PCBA)
- 4 sustainers for metal cabinet's mounting
- 1 Installation Manual

## COMPLIANCE

Europe - CE  
EAC



**auxi** deriva dal latino e significa **crescere, aumentare, potenziare.**  
*auxi derives from Latin and means to increase, to potentiate.*

**auxi-L** is an Expansion Module with 5 Relays outputs operating at 250V-8A (10A peak), with 1 common Terminal, ideal for Light Management and for disconnecting Appliances.

As all the other Expansion Modules of Ksenia Security, it has very compact dimensions (only 70x45mm) enabling room savings, it can be installed either inside the DIN-503 Boxes and on DIN guide reducing dramatically the installation time.

**auxi-L** is to be connected to the **lares 4.0** by means of the 4 wires Serial KS-BUS.

**Perché auxi-L**  
*why auxi-L*

- **because** it has 5 relay outputs, with a common terminal, which allow a clean wiring to control lights and loads in general;
- **because** each relay is able to handle loads up to 8A at 250Vac;
- **because** with only one expansion module you can extend the number of input terminals available on your system;
- **because** it is automatically configurable by means of its serial number: no need to adjust dip-switches on board;
- **because** it is very small and therefore can be installed inside the wall within a standard DIN503 box.
- **because** it can be housed in a suitable plastic box for fixing on DIN rail.

# auxi expansion module

product code **KS12300000.300** - auxi PCBA



## TECHNICAL DATA

- **Voltage:** 13,8 Vdc
- **Current consumption:** 20 mA (excluding terminal P and outputs)
- **Alarm inputs:** Up to 5 (with programmable EOL)
- **Analog output 1** @ 0 – 10 V, 20 mA
- **Open Collector outputs:** Up to 5 da 500mA each
- **Power terminal:** 0,5 A (protected by a self-restorable thermal fuse)
- **PCBA dimension:** 75x45x16 mm (l x h x p)

## PARTS INCLUDED

- 1 auxi expansion module (PCBA)
- 4 sustainers for metal cabinet's mounting
- 1 Installation Manual

## HOW TO ORDER

- **KS12300000.300** - PCBA auxi

## ACCESSORIES

- **KS17300000.001** - Plastic box for DIN rail
- **KS17302000.010** - Plastic box "slim" version

## CERTIFICATIONS

Europe - CE  
EAC  
EN50131 Grade 3 - Class II  
T014:2013  
SSF 1014 Larmclass 3

**auxi** deriva dal latino e significa *crescere, aumentare, potenziare*.  
*auxi derives from Latin and means to increase, to potentiate.*

**auxi** is an expansion module that gives the opportunity to increase the number of inputs or outputs up to 5 on the lares 4.0 control panels. It is possible to program an auxi terminal (M5) as 0-10V analog output which can be connected to actuators capable of detecting voltage variations. More specifically, auxi analog output can be used as an intensity regulator (dimmer), allowing to increase and decrease the brightness. This, in fact, can be controlled using the relevant scroll bar: the colour intensity will change accordingly to the selected percentage; from 5 to 100% in steps of 0.5V. The end user can manage this feature from lares 4.0 App, ergo-T / ergo-T plus keyboards and from the graphic maps.

**perché auxi**  
**why auxi**

- **because** with a single expansion module it is possible to increase control panel's inputs and outputs;
- **because** it is automatically set up through its serial number, avoiding the needs of manual dip-switch installation;
- **because** one of its 5 terminals is programmable as a 0-10V analogue output, capable of regulating the output voltage, useful for example for dimming lights;
- **because** with the dimmer feature, the user can reach a total customization of his environments;
- **because** all its 5 terminals can be programmed as inputs with EOL resistors.



# auxi wls bi-directional wireless I/O module

product code **KSI2300002.300** - auxi wls



34

SMART HOME SOLUTIONS / auxi wls



## TECHNICAL DATA auxi wls

- Power supply: 110 -230 VAC 50-60Hz
- Operative range: 868 MHz
- Operative range in open air: up to 150 m
- Inputs: Nr. 2
- Outputs: Nr. 2 (5A 250Vac - 5A 30Vdc)
- Operative temperature range: -20 to + 55 °C
- Dimensions: 42 x 35 x 20 mm
- Protection class: IP20

## PARTS INCLUDED

- 1 PCBA Module
- 1 Plastic case
- 1 Installation manual

## HOW TO ORDER

- KSI2300002.300 - auxi wls module

## COMPLIANCE

Europe - CE , RoHs  
EAC



## FUNCTIONS

**auxi wls** is a wireless module with 2 inputs and 2 outputs on board. **Powered directly from the mains**, **auxi wls** is ideal for the remote control of lights, home automations (such as roller blinds and curtains) and, generally, any load unreachable by cables.

**auxi wls** can be used in conjunction with lares 4.0 Control Panels or as a stand-alone device. In the second case, the outputs can be controlled locally (using the inputs on board) or remotely (using the opera remote control). Up to 32 different remote controls can be enrolled for each **auxi wls**.

His compact size allows to fit it in small spaces such as DIN503 wall boxes (1 slot)

Additionally to the Mono-stable or Bi-stable modes, outputs can be configured as follows:

- 2 independent outputs: each output can be managed as single
- Change over switch: once the first output closes, the second one opens (useful to replace outputs already installed)
- Interlocked: useful to manage automatic roller blinds (there is a delay before the closing of the output)



# porta 4.0 Konnex Gateway

product code **KSI4300001.300** - porta 4.0



Detail of the **porta 4.0** module installed



## TECHNICAL DATA

- Power Supply: 12 - 24VDC or PoE
- Consumption: 5W max
- Communication BUS: KNX
- Ethernet interface: RJ45
- Operating range: +5 to +40°C
- Dimensions: 86 x 69 x 58mm
- Weight: 130g

## HOW TO ORDER

- KSI4300001.300 - porta 4.0 KNX Gateway

## PARTS INCLUDED

- 1 porta 4.0 KNX Gateway
- 1 Installation manual

## COMPLIANCE

Europe - CE  
EAC

**porta** deriva dal latino e significa **accesso, passaggio**.  
**porta** derives from Latin and means **access, passage**.

Nowadays, KNX technology is the open, world-recognized standard, compliant with the main European and International standards, for automated and decentralized management of a wide variety of structures: commercial buildings, industries, offices, residentials, public places, schools, and so much more.

**porta 4.0**, a KNX compatible device, can take control of all Ksenia lares 4.0 control panels family, through standard KNX devices.

In fact, when the gateway **porta 4.0** receives a Konnex datagram, it is possible to perform the following operations on lares 4.0 control panel:

- Management of monostable / bistable outputs;
- Exclusion / inclusion zones;
- Scenarios implementation.

Moreover, when one of the following events occurs on lares 4.0 control panel:

- Status change of a zone;
- Status change of a partition;
- A fault.

The whole configuration is instead carried out through the web interface for configuring the lares 4.0 control panel, therefore it can be performed locally or remotely, by using a PC/MAC or a mobile device. The device is connected to the control panel via Ethernet and can be powered by PoE or by external power supply (12 / 24Vdc).

**porta 4.0** is supplied with a plastic box that occupies 4 DIN modules.

### Perché **porta 4.0** why **porta 4.0**

- because it allows a bidirectional interface between lares 4.0 control panel and KNX world;
- because it does not need any dedicated driver, it is completely recognized and can be programmed by lares 4.0 control panel;
- because it is powered directly by PoE or by external power supply.

# Welcome to the Smart Home: Control4 & Crestron

36

SMART HOME SOLUTIONS / Crestron & Control4

Ksenia Security has developed two drivers capable of integrating all the lares 4.0 control panel series, respectively in the Control4 and Crestron worlds.

Therefore, within the Control4 and Crestron Security management interfaces, it is possible to manage many functions of the lares 4.0 control panel: partitions, zones, outputs, scenario activation, etc. Furthermore, when events occur on the lares 4.0 control panel, it is possible to perform some actions on the Control4 and Crestron devices.

## Control4

Control4 is one of the main leading providers of personalized automation and control solutions that allow the user to virtually control any device installed at home or in the office.

Control4 was founded in 2003, the company's mission is to offer a smart and more convenient way to control and automate lighting, music, video, energy, of a single room or the entire house.

Thanks to the collaboration with the most important consumer electronics, household appliances, energy and lighting brands, Control4 is a leader in the sector of interoperability, ensuring a continuous expansion of the ecosystem of connected devices that will work together at home or in the company.

## Crestron

Crestron Electronics has carved the path for technological innovation since 1971. Crestron creates automation solutions that transform the way people live their lives, making their day-to-day tasks easier and improving efficiency and productivity. Crestron engineers high-tech solutions for every market. From customized luxury smart home automation to scalable out-of-the-box collaborative tools, Crestron provides award-winning, leading-edge technology and outstanding customer experiences, better solutions that address the needs of customers the world over. Crestron has solution for Audio/video distribution, Lighting control, Building Management Systems (BMS), GUI design software, Speakers and much more!

**Ksenia**  
security innovation

Control4

 **CRESTRON**

# Google Home & Alexa: complete integration

## Your voice is a powerful resource\*

Technological progress has inevitably changed our habits and greatly simplified our daily actions.

Ksenia Security, protagonist in this major expansion, has created a concentrated blend of possibilities that can combine, at the same time, innovation and simplicity of use. So, the integration between lares 4.0 and the virtual assistants Google Home and Amazon Alexa was born.

Intelligent digital assistants have revolutionized the way people interact with objects and technology, in particular, with home and Home Automation solutions. Today, thanks to the voice assistance function that distinguishes Alexa and Google Home, Users can manage all the Smart devices in their home through a simple voice command.

This has a strong impact, for example, in situations of motor disabilities, greatly simplifying daily actions within the home: management of blinds, monitoring of lights, coordination of scenarios and the full power of all the desired automations.

It is the real case in which technological innovation is at the service of people, to satisfy every type of need.

In this way, Home Automation becomes a convenient daily ally, helping to create a higher level of interaction with one's home through a perfect User Experience. To all this is added a surprising ease of use, thanks to the support of the APP lares 4.0 that offers numerous functions and a true graphic customization.

A real guarantee of being "always connected" even with the protection of one's own home. All you have to do is control the Ksenia Security and lares 4.0 Home Automation using your voice!

## lares 4.0 is evolving and expands its functionality.

lares 4.0 is Ksenia Security's hybrid IoT platform that fully interprets the Digital Revolution. It is a unique solution, with high innovative potential, able to guarantee Security and Home Automation for every type of application. A double deal for those who install a lares 4.0 in

their home or business.

It responds with an integrated solution to the request of the customer who wishes to secure his residence and, at the same time, manage the energy resources of his home, by installing an Home Automation system, with the possibility to control the whole system from a single APP, via smartphone or tablet.

He currently holds a predominant position in the digitization era, in terms of physical security (Intrusion, Video Verification, Access Control) and Home & Building Automation. lares 4.0 is evolving and expands its functionality thanks to complete integration with intelligent personal assistants Google Home and Amazon Alexa.

From this union comes the great opportunity to manage all Smart devices in your home and, thanks to the voice assistance function, you can simply use the voice.

\* The use of voice assistants may decrease the level of Security of the system.



# COMMUNICATION SYSTEMS FOR lares 4.0



gemino IoT.....	40
4G module .....	44
PSTN module .....	45





NETWORK  
4G/LTE

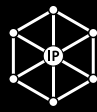

IP NETWORK



REMOTE



HIGH-TECH



FULL  
BACK UP

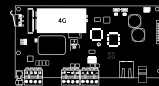

EASY TO  
ADD-ON

# gemino IoT comunicator 4G-LTE/IP

product code KSI4104000.310 - gemino IoT



## TECHNICAL DATA

- **Power supply:** PoE 13W or 12VDC
- **Current consumption:** PoE class 3 (12.95W) / 80mA stand-by, 250mA max
- **GSM bands:** GSM 4G Module u-blox
- **Maximum data rate:** 10 Mbit/s in download, 5 Mbit/s in upload
- **Maximum transmission time of vocal alarm:** 10 sec.
- **Alarm transmission system:** SP2 - SP4 - DP3
- **External antenna connector type:** SMA
- **Operating temperature:** -10 +55°C
- **Humidity:** 95%
- **PCBA dimensions:** 92x113x20 mm (hxlxp)
- **Max overall dimensions:** 140x102x30 mm (hxlxp)
- **Weight:** 190 gr

## INCLUDED PARTS

- 1 comunicator gemino IoT (PCBA)
- 1 'Slim' plastic box
- 1 Installation Manual

## HOW TO ORDER

- KSI4104000.310 - PCBA

## ACCESSORIES

- KSI4800005.300 - External 4G antenna Kit with wall-mounting bracket, connectors and 10 m cable.

## COMPLIANCE

Europe - CE, RoHS  
EN50131 Grade 3 class II  
EN50136 Grade 3 class II

**gemino** deriva dal latino e significa **unire strettamente, mettere uno accanto all'altro.**

**gemino** derives from Latin and means **closely related/linked or to put one next to the other.**

**gemino IoT 4G-LTE/IP** Comunicator is an additional device that increases the communication capabilities of the lares 4.0 IoT platform thanks to the M2M 'u-blox' Cat.1 professional module. It works on two transmission channels: crypted Ethernet/IP (with proprietary protocol) and 4G-LTE (Long Term Evolution) data network, with band 3, band 7 and band 20 (800, 1800 and 2600 MHz respectively).

**gemino IoT** is equipped with an Ethernet port and a micro-SIM card slot on board and it is designed to remotely control Dual-Path communication on lares 4.0 control panels.

**gemino IoT** allows lares 4.0 IoT platforms, installed on sites that do not have sufficient GSM coverage, to be reachable from 4G data network (with reception also on 2G and GPRS bands) or via Internet, in a completely transparent way for the installer and enduser as well. All of the above is related to specific features, such as programming and management of the control panel, push notifications when events occur, sending reports with SIA DC09 digital protocol with supervision of channel and receiver (dual-path), video verification of IP cameras connected to the local network. Finally, it includes easy management and fast synchronization of voice messaging, thanks to the now consolidated partnership with TTS Loquendo® of Nuance Communication.

In addition, **gemino IoT** allows the supervision and therefore the sending of voice, SMS and Contact ID reports when any of the events programmed occur. Also it provides a high-speed data channel (up to 10Mbit/s in download) able to offer a complete back-up of communication network in the event of failure or temporary lack of coverage, from the 4G network to the IP-LAN network and vice versa, ensuring a total communication and data security.

**gemino IoT** has to be installed where the lares 4.0 IoT platform resides, in the same LAN infrastructure through the Ethernet port. The device is supplied with a plastic case for wall mounting, with special openings for connecting the Ethernet network cable and an external antenna if necessary (as an alternative to the internal one). It is powered by PoE or, alternatively, by 12V external power supply.

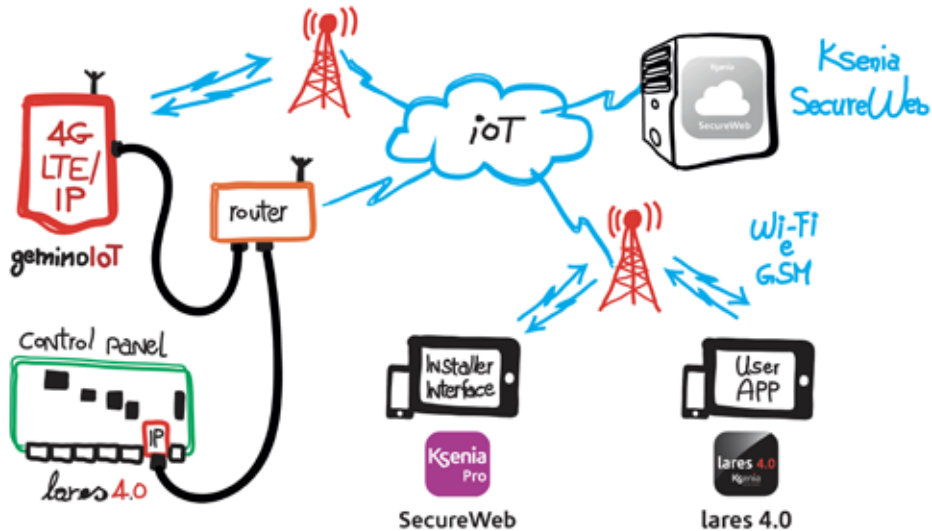

geminoIoT can be back-up of IP  
and vice versa.

#### Perché gemino IoT why gemino IoT

- **because** it supports 4G-LTE connectivity, fourth generation network for data transmission on a high-speed mobile network, up to 10Mbit/s in download. 4G-LTE technology improves performance and communications and provides great advantage in reliability of connections and high speed;
- **because** you are allowed to choose the most suitable position to install gemino IoT, for the best reception of the mobile network signal. As gemino IoT is connected to lares 4.0 router platform via Ethernet and powered by PoE, it is not constrained by the position occupied by the central unit but aimed to guarantee best coverage;
- **because** it is possible to use gemino IoT as a ROUTER in the absence of wired internet connection. In this mode, gemino IoT implements a DHCP server that automatically provides and assigns IP addresses to each device on the same network, allowing the connection to internet through the data connection guaranteed by the module 4G/LTE;
- **because** it communicates through the IP network: on one side toward lares 4.0 platform, which guarantees adequate speed for data traffic and for communications offered by the services provided, and on the other side it ensures 4G-LTE network redundancy, for a complete back-up of communications, in case of failure or temporary lack of coverage (switching from 4G network to IP network and vice versa);
- **because** it represents the natural technological evolution of the add-on module (gemino BUS 3G) transitioning to 4G-LTE network, maintaining the same functionalities: remote configuration of the control panel through Ksenia PRO application or from Ksenia SecureWeb service, remote management by end-users with lares 4.0 application, sending of messages using the SIA DC09 protocol, notifications via SMS, e-mail, voice messages, Push notifications and Contact ID;
- **because** it is provided in an extremely compact (140x102x30 mm) case, it also implements the internal antenna on board, that makes it a modern technological and design product.

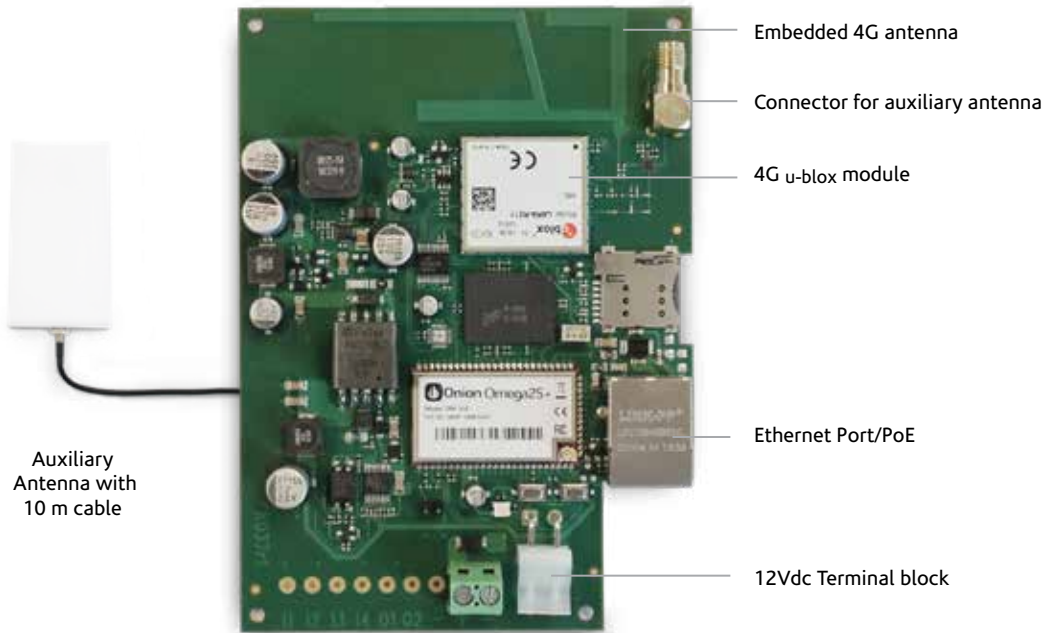

## ROUTER MODALITY

It is possible to use gemino IoT as a ROUTER in the absence of wired internet connection. In this mode, gemino IoT implements a DHCP server that automatically provides and assigns IP addresses to each device on the same network, allowing the connection to internet through the data connection guaranteed by the module 4G/LTE. It can establish connection via 4G/LTE technology (up to 10 Mbps in download and 5 Mbps in upload) with 2G/EGDE fall-back. This allows any IP device (client), with IP address assigned by the DHCP server, to route all traffic to internet through 4G data network.

The router functionality allows you to create a private network to connect all the Security devices: it is possible to access the system from SecureWeb, through the user APP and the installer APP, configure the system locally by connecting a PC to the network created by the device itself, so IP configuration of all connected devices is avoided. Finally, gemino IoT keeps on functioning as a warning / communicator: phone calls, SMS, e-mails, reports to security, are transmitted keeping data connection alive.

The Ksenia SecureWeb service is reserved to professional installers; it offers the possibility to configure the whole lares 4.0 IoT platform by connecting directly to the portal [www.kseniasecureweb.com](http://www.kseniasecureweb.com) (via PC/MAC) or via the "Ksenia Pro" APP, it is available for download from the App Store (Android or iOS), for any mobile device, smartphone or tablet, free of charge.

The SecureWeb portal, as well as the "Ksenia Pro" APP, satisfies, through an intuitive and user-friendly graphical interface, all the technical aspects related to the configuration of the plants, including maintenance, remotely automatic updates of firmware (central unit and peripheral cards) and real-time monitoring of the systems installed in the field.

## PROGRAMMING

gemino IoT 4G-LTE/IP communicator is automatically acquired by lares 4.0 by entering the MAC Address printed on the label on the device. If DHCP protocol is enabled, it does not require the manual assignment of the IP address. The few customization data are required if you have to use the external antenna, instead of the internal one and you want enable the device supervision; from GSM side it is possible to disable data traffic and, if necessary, customize the authentication data of your carrier's APN (Access Point Name).

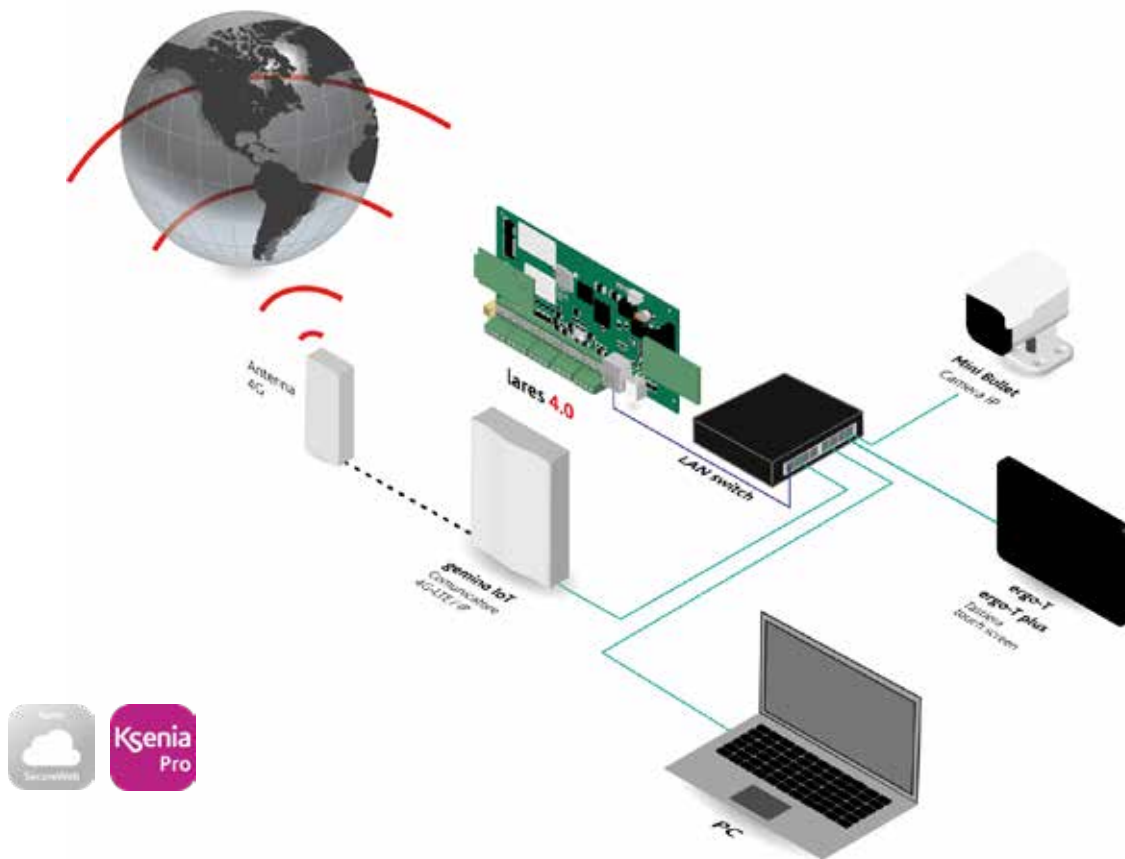

## ROUTER MODE ACTIVATION

Depending on the firmware version of gemino IoT, it is possible to use the device as a router in the absence of wired internet connection. In this mode, gemino IoT implements a DHCP server that automatically provides and assigns IP addresses to each device on the same network. Moreover, it allows them to connect to internet network through the data connection guaranteed by the GSM module: it can establish connection via 4G technology if available (up to 10 Mbps in download and 5 Mbps in upload) or in EDGE (or 2G).

Router mode must be used in the absence of another router (or ADSL modem/router) on the same network to avoid IP address conflicts (since both of them assign IP addresses on their network, that could be different, with the result that some clients can accept addresses from different servers).

In order to function as a router, gemino IoT does not need to be configured in the lares 4.0 control panel: if it is not configured, the control panel is connected to the internet network via LAN (as if you were using a normal home modem/router).

When the gemino IoT works as router, it ignores the IP address and DHCP parameters that may be present in the configuration and it uses the static IP address 192.168.100.1.

All other configurations remain valid and voice calls and SMS will work regularly.



# 4G/LTE add-on module

product code KSI4104001.300 - 4G/LTE module

44

COMMUNICATION SYSTEM for lares 4.0 / 4G/LTE module



Antenna 4G with 10m cable  
KSI4800005.300



Antenna 4G with 30 cm cable  
KSI4800006.300

Add-on **4G/LTE** module supports 4G/LTE connectivity, fourth generation network for data transmission on a high-speed mobile network, up to 10Mbit/s in download. 4G/LTE technology improves performance and communications to obtain a best reliability and speed of the links.

Add-on **4G/LTE** module is an easy installation module, directly plugged into the lares 4.0 control panel motherboard. Using 4G/LTE (Long Term Evolution) data network, with band 3, band 7 and band 20 (800, 1800 and 2600 MHz respectively) it extends the communication capabilities of lares 4.0 control panel.

It also provides a high-speed data channel (up to 10Mbit/s in download) able to do a complete back-up of communication network in case of failure or temporary lack of coverage, from 4G network to the IP-LAN network and vice versa, ensuring total security of data and communications, or even be the only data channel available of the control panel.

## TECHNICAL DATA

- Interface mini PCI-express
- Power supply: 3.3 Vdc
- Current consumption: 50 mA stand-by, 2.2 A max
- UMTS Bands: 800 MHz / 1800 MHz / 2600 MHz
- GSM Bands: GSM 4G Module u-blox
- Maximum data rate: 10 Mbit/s in download, 5 Mbit/s in upload
- Maximum transmission time of vocal alarm: 10 sec.
- Alarm transmission system: SP2 - SP4 - DP3
- External antenna connector type: SMA
- Operating temperature: +5°C to +40°C
- Compatible SIM type: micro
- PCBA dimensions: 36x62x14 mm

## PARTS INCLUDED

- 1 add-on 4G/LTE module (PCBA)
- 1 PCBA Support holder

## HOW TO ORDER

- KSI4104001.300 - 4G/LTE module PCBA

## ACCESSORIES

- KSI4800006.300 - Antenna 4G with 30 cm cable
- KSI4800005.300 - Antenna 4G with 10m cable

## COMPLIANCE

Europe - CE, RoHS

Regardless of the Internet connection over IP, with the addition of the 4G/LTE module, lares 4.0 will be enriched with the following features:

1. Remote configuration of the control panel through free Ksenia PRO App for installer or from Ksenia SecureWeb service;
2. Remote management of the control panel through free lares 4.0 APP for users;
3. Sending of messages using the SIA DC09 digital protocol, with channel and receiver supervision;
4. Notifications via SMS, e-mail, voice messages, Push notifications;
5. Possibility of video-verification of ONVIF IP cameras connected to the local network;
6. Contact ID protocol to the Surveillance Centers is guaranteed.

# PSTN add-on module

product code KSI4200001.300 - PSTN add-on for lares 4.0



## TECHNICAL DATA

- Add-on Modul with 16 pole connectors
- Power Supply: 12 Vdc and 3,3 Vdc
- Current consumption: 10 mA on 12 V, 30 mA on 3,3V
- Operating temperature: +5°C to +40°C
- Connector RJ-11
- PCBA dimensions: 80x38x16 mm

## PARTS INCLUDED

- 1 PSTN (PCBA) add-on module
- 2 Sustainers for PCBA
- 1 Installation Manual

## HOW TO ORDER

- KSI4200001.300 - PCBA

## CERTIFICATIONS

Europe - CE, RoHS  
EAC  
EN50136 Grade 2 - Class II  
T031: 2017



Using the PSTN module, the communication capabilities of lares 4.0 control panel can be extended. It allows the sending of voice messages and contact ID when any of the events programmed in the control panel occurs. It is a quick installation module, plugged into the control panel motherboard, and connected to the telephone line through a standard RJ-11 connector.

Another connector, always RJ-11, allows the connection of telephones and other devices that use the telephone line, in case of alarm the device is therefore able to start the communications by disconnecting all the other devices that use the telephone line. It can work either as a back-up of 3G (or GSM) module or as main line.

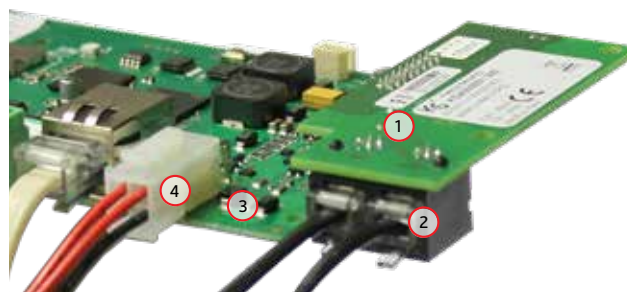

- |                   |                     |
|-------------------|---------------------|
| ① PSTN module     | ③ lares 4.0 PCBA    |
| ② Phone line plug | ④ Power supply plug |

## WIRELESS TECHNOLOGY



opera.....	48	velum-C wls .....	55
ergo wls.....	50	matrix.....	56
unum wls.....	51	imago.....	58
poli .....	52	duo.....	60
nanus poli .....	53	universal duo .....	61
velum wls .....	54	nebula .....	62



868  
MHZ

FREQUENCY  
BAND

DPMS

DYNAMIC POWER  
MANAGEMENT  
SYSTEM



BIDIRECTIONAL  
COMMUNICATION



VERY LONG  
BATTERY LIFE



DESIGN



CODED  
COMMUNICATION



#### I Dispositivi wireless

Sono stati progettati con le seguenti caratteristiche per ridurre l'impatto ambientale:

1. Plastiche senza PVC
2. Laminati senza Alogeno e circuiti stampati senza piombo
3. Basso assorbimento, in modo da minimizzare la necessità di sostituzione delle batterie
4. Imballo realizzato per la maggior parte con fibre riciclate e materiali provenienti da fonti rinnovabili

#### Wireless devices

have been designed and manufactured for the environment as follows:

1. PVC free
2. Halogen free laminates and lead-free PCBA
3. Low current consumption, in order to increase the battery life and avoid unnecessary replacement
4. Packaging mainly produced with recycled fibers and materials

# opera Remote Control

product code **KSI7700000.00X** - opera control, different colors

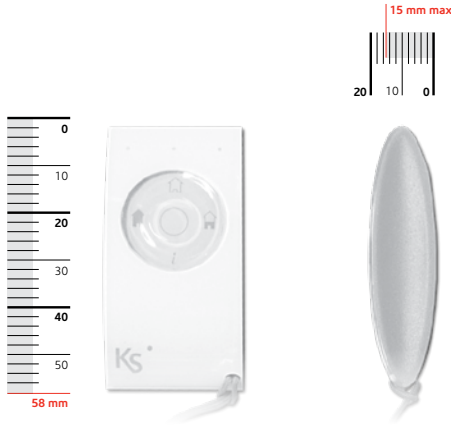

## TECHNICAL DATA

- **Power:** 1 Lithium Battery Type CR2032A included (up to 6 years max. duration time)
- **Operational Frequency:** 868 MHz Band
- **Operation Range (open-air):** up to 400 m
- **Operative Temperature Range:** from +5°C to +40° C
- **Overall Dimensions:** 30 x 58 x 15 mm (hwxwd)
- **Vibration:** adjustable duration and switch-off option for energy saving purposes

## PARTS INCLUDED

- 1 opera remote control
- 1 CR-2032 battery
- 1 Lanyard
- 1 User Guide IT / EN / FR

## HOW TO ORDER

- **KSI7700000.001** - White opera control
- **KSI7700000.002** - Black opera control
- **KSI7700000.003** - Grey opera control
- **KSI7700000.008** - Red opera control

## ACCESSORIES

- **KSI7203002.000** - Button battery CR2032 (200 pcs per pack)

## CERTIFICATIONS

Europe - CE, RoHS  
EAC  
EN50131 Grade 2 - Class II  
T014A:2013

*opera* deriva dal latino e significa **lavoro, servizio, comodità**.  
*opera* derives from Latin means **work, service, easiness**.



**opera:** it is a remote control with a revolutionary design, both ergonomic and minimalist.

Thanks to the bi-directional communication, **opera** is not limited to the possibility to **activate up to 7 different scenarios**, but also to deliver in any moment the **system status** (arm, away and stay) visualized by one of the 3 LEDs positioned on the upper part. The activation of any scenario is confirmed both visually (through the relevant LED) and by means of a **vibra-motor device**.

The implementation of a complex encryption algorithm guarantees a superior Security level and contemporary allows the utilization of the same remote control's device even with different installations (e.g. main residence and sea cottage).

**opera** is available in the 4 Ksenia institutional colors, i.e. White, Red, Grey and Black.

The **panic function** could be also activated by a prolonged pressing of each of the 4 bottoms (or 7 Functions). Any key of the remote control can be pressed to activate the PANIC/SOS function, triggering a series of actions such as voice calls, SMS, e-mail, whose addressees, as well as the actions to be performed, are preconfigured in the lares 4.0 control panel. In this mode, the PANIC/SOS signal is also sent by pressing the central button of opera, which normally indicates the battery status.

## Scenario Function



## Panic/SOS Function



### Perché opera why opera

- **because** it includes the most advanced Wireless Technology, 868 MHz, completely bi-directional, professional and reliable;
- **because** it integrates the DPMS Technology (Dynamic Power Management System) which allows less interferences and extends the battery life;
- **because** in case of MULTI-RECEIVER system it is able to automatically choose the best radio path;
- **because** the communication is completely encrypted by proprietary algorithm;
- **because** in real time it allows to visualize the system status (after the confirm reception) by visual signalation (three red LEDs);
- **because** it is the only remote control with four bivalent function keys (extended pressure for other scenarios activation);
- **because** it has a revolutionary design which remember the keypads circular scroll;
- **because** it has extremely small size;
- **because** it is the only one equipped of vibration motor for received command tactile confirmation;
- **because** it is available in four colors: White, Grey, Black and Red;
- **because** it is provided with the alternative numeric Keypad, easily interchangeable and useful to use opera in domotic purposes.

# ergo wls keypad

product code KSI2100022.311 - ergo wls white  
KSI2100022.312 - ergo wls black



## MAIN CHARACTERISTICS

- Dot matrix LCD (visible area 79 × 19 mm)
- Mechanical keys cropped laser
- Available to the final customer in the colors white, black Ksenia
- Backlight and contrast adjustment
- Fast Addressing System: no need to pre-address setting device (automatic detection of the Control Panel / communicator)

## PARTS INCLUDED

- 1 ergo wls keypad
- 1 3V-1900mAh battery
- 1 User Guide IT / EN / FR

## HOW TO ORDER

- KSI2100022.311- ergo wls white
- KSI2100022.312 - ergo wls black

## ACCESSORIES

- KSI7203019.000 - Lithium Battery Pack 3V-1900mAh (non rechargeable)

## CERTIFICATIONS

Europa - CE, RoHS  
EAC



## Perché ergo wls why ergo wls

In the new ergo wls have been included all the qualitative features developed for the ergo M keypad and added the wireless communication capabilities, to make it the best wireless solution for the management of lares 4.0 wls 96 Control Panel.

- **because** it includes the most advanced Wireless Technology, 868 MHz, completely bi-directional, professional and reliable.
- **because** it integrates the DPMS Technology (Dynamic Power Management System) which allows less interferences and extends the battery life.

## FUNCTIONS

- Display of System Status
- Display of operating parameters
- System Commands (complete or partial arming, reset, activation of output terminals, telephone calls, etc.)
- Full Programming of System Parameters / Panel
- Execution of the scenarios
- Exclusion of zones in alarm on the system activation.
- Reset the alarm in progress
- Reset communications



# unum wls Indoor Motion Detector

product code **KSI5201000.300** - PIR  
**KSI5201100.300** - PIR + Pet Immune



## Perché unum wls why unum wls

- **because** it is a digital sensor with double optic.
- **because** it includes the most advanced Wireless Technology, 868 MHz, completely bi-directional, professional and reliable.
- **because** it integrates the DPMS Technology (Dynamic Power Management System) which allows less interferences and extends the battery life.
- **because** in case of MULTI-RECEIVER system it is able to automatically choose the best radio path.
- **because** when the alarm is disarmed it is possible to set the sensor in sleep mode, keeping the complete supervision.
- **because** it has a unique aesthetic - minimalist and discreet different from the rest.
- **because** unum detectors apply the new ELT Technology (Embedded Lens Technology), which takes advantage from decades of experience in designing professional lens for motion detection purposes, thus enabling to achieve the objective to literally make the lens disappearing from the detector profile, thanks to very sophisticated techniques which also use the same special material of the lens (HDPE), to basically allow it to be fully embedded, completely integrated in the front cover itself;
- **because** they do not need, unlike other products in the market, to have on their front side all those colored lights (LEDs) which very often the installers need to disable because too annoying for the end-users;

## TECHNICAL DATA

- **IR Sensor:** Dual Element Digi Pyro
- **Power:** 1 CR123A Lithium battery included for a maximum battery life up to 4 years
- **RF immunity:** 20 V/m, 10-1000 MHz; 10 V/m, 1-2 GHz
- **White Light Immunity:** 6500 lux
- **Sensitivity:** adjustable at 2 or 3 impulses
- **Coverage:** adjustable from software or Keypad at 6 or 12 m. range
- **Operational Frequency:** 868 MHz
- **Open Air Range:** up to 400 m
- **Operative Temperature Range:** from +5 °C to +40 °C
- **Materials:** Base: ABS; Front: HDPE
- **Dimensions:** 113 x 60 x 45 mm (h x w x d)

## PARTS INCLUDED

- 1 unum wls motion detector
- 1 CR-123A battery
- 1 Installation manual

## HOW TO ORDER

- **KSI5201000.300** - PIR version
- **KSI5201100.300** - PIR plus Pet Immune version

## ACCESSORIES

- **KSI5900000.300** - adjustable bracket for wall mounting
- **KSI7203015.000** - Lithium battery CR123-A

## CERTIFICATIONS

Europe - CE, RoHS  
EN50131 Grade 2 - Class II  
T031:2014  
SSF 1014 Larmklass R



## FUNCTIONS

unum wireless, is a digital Dual-Optic Motion Detector available in 2 versions, with and without Pet Immunity

The Motion sensor is a **dual PIR Digi Pyro™** with high Quality **EvenEye™** Lens.

Thanks to the Bi-Directional wls Technology, **the range selection (6 or 12 m.) and the number of impulses programmable directly from the basis software don't require selecting jumpers or annoying dip-switches; furthermore it's possible to modify the configuration with no need to re-open it.**

Additionally, it is possible **to deactivate the PIR sensor when the system is disarmed (default setting) so as to reduce drastically the current consumption** with consequent increase of the battery life.

Instead, with particular reference to Home-Automation applications, it is possible to program the PIR sensor to be always powered.

# poli Magnetic Contact

product code **KSI5001000.301** - White poli  
**KSI5001000.303** - Grey poli  
**KSI5001000.304** - Brown poli



52

WIRELESS TECHNOLOGY / poli

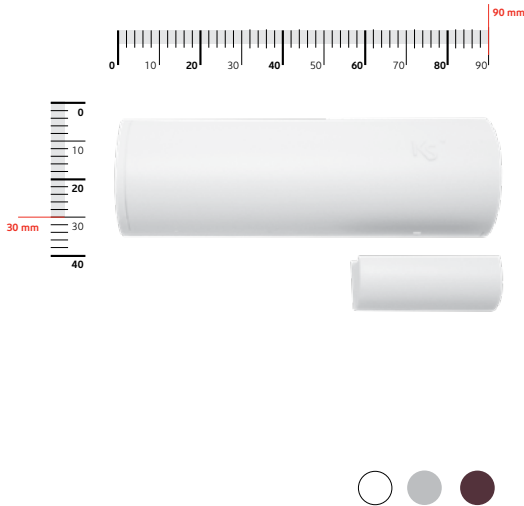

*poli deriva dal latino e significa polo.  
poli derives from Latin means pole.*

**poli** is a wireless magnetic contact with 2 auxiliary inputs, integral part of the 868 MHz Bi-Directional System of Ksenia.

**poli** is identified, as all Ksenia Security Products, by an unique and exclusive design which develops itself around the Battery volume as the major constraint. It integrates inside **2 programmable inputs** which can be used to connect external wired magnetic contacts rather than wired curtain detectors, glass brake detectors and/or wired roller blind detectors, rendering it, as a matter of fact, as a **small wireless expansion module (up to 3 zones)**.

Thanks to its Bi-Directional Communication, the input configuration (**type, number of impulses, balance**) are programmable directly from the basis software.

As all the other KSENIA wls devices, the poli magnetic contact implements DPMS (Dynamic Power Management System), the possibility to program the supervision time from minimum of 1 minute to a maximum of 240 minutes (default set-up: 5 minutes), the battery status control (with signal warning transmission when its substitution is recommended), and integrates 2 tamper ( on the opening and on its removal).

**poli** is available in 3 colors: White, Brown and Grey to make it suitable to the different installation requirements.

## TECHNICAL DATA

- **Power:** 1 Lithium Battery Type CR123A included for a max. duration time up to 4 years
- **Operative Frequency:** 868 MHz Band
- **Inputs:** Nr.2 programmable balanced
- **Range in open air:** up to 400 m
- **Operative Temperature Range:** +5 °C to +40 °C
- **Contact Dimensions:** 30 x 90 x 30 mm (HxWxD)
- **Magnet Dimensions:** 15 x 34 x 14 mm (HxWxD)

## PARTS INCLUDED

- 1 poli magnetic contact
- 1 CR-123A battery
- 1 Quick Installation Guide

## HOW TO ORDER

- **KSI5001000.301** - White poli
- **KSI5001000.303** - Grey poli
- **KSI5001000.304** - Brown poli

## ACCESSORIES

- **KSI7203015.000** - Lithium battery CR123A (200 pcs per pack)

## CERTIFICATIONS

Europe - RoHS, CE  
EN50131 Grade 2 - Class II  
T014A:2013  
SSF 1014 Larmklass R



*perché poli  
why poli*

- **because** it includes the most advanced Wireless Technology, 868MHz, completely bi-directional, professional and reliable.
- **because** it integrates the DPMS Technology (Dynamic Power Management System) which allows less interferences and extends the battery life.
- **because** in case of MULTI-RECEIVER system it is able to automatically choose the best radio path.
- **because** it can manage two independent wired inputs / zones (roller blind and glass break).
- **because** it integrates a solid state Reed sensor and not a mechanically more fragile glass component.
- **because** it has a unique aesthetic - minimalist and discreet different from the rest, being the result of many accurate studies and shapes developed around the battery volume.
- **because** in addition to the white and brown it is available also in grey for installations on stainless steel and aluminium frames.

# nanus poli Micro Magnetic Contact

product code **KSI5002000.301** - White nanus poli  
**KSI5002000.303** - Grey nanus poli  
**KSI5002000.304** - Brown nanus poli

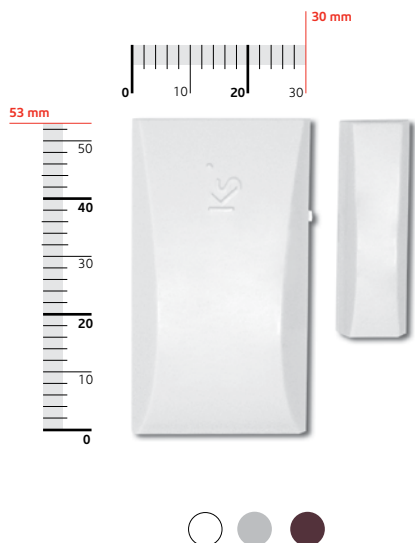

## TECHNICAL DATA

- **Power supply:** 1 provided lithium battery CR2032 included for a max life expectancy up to 3 years
- **Operating frequency:** 868 MHz
- **Range in open air:** up to 300 m
- **Operating temperature range:** +5° to +40 °C
- **Contact Dimensions:** 30 x 53 x 10 mm (HxWxD)
- **Magnet Dimensions:** 12 x 36 x 09 mm (HxWxD)

## PARTS INCLUDED

- 1 nanus poli magnetic contact
- 1 CR-2032 Battery
- 1 Installation Manual

## HOW TO ORDER

- **KSI5002000.301** - White nanus poli
- **KSI5002000.303** - Grey nanus poli
- **KSI5002000.304** - Brown nanus poli
- 

## ACCESSORIES

- **KSI7203002.000** - Button battery CR2032 (200 pcs per pack)

## COMPLIANCE

Europe - CE, RoHS  
EAC



**poli** deriva dal latino e significa **polo**.  
*poli derives from Latin means polo.*

**nanus poli** is a wireless micro magnetic contact, integral part of the 868 MHz Bi-Directional System of Ksenia.

**nanus poli** is identified, as all Ksenia Security Products, by a unique and exclusive design which develops itself around the Battery volume as the major constraint.

As all the other KSENIA wls devices, the nanus poli magnetic contact implements DPMS (Dynamic Power Management System), the possibility to program the supervision time from minimum of 1 minute to a maximum of 240 minutes (default set-up: 5 minutes), the battery status control (with signal warning transmission when its substitution is recommended), and integrates a tamper on the opening.

**nanus poli** has a unique serial number which is being automatically acquired by the system during the installation phase; both the basis programming software and the ergo keypads indicate in real time the signal level of each device and communication path in the case that more BUS Transceivers or Repeaters are present in the same architecture.

**nanus poli** is available in 3 colors: White, Brown and Grey to make it suitable to the different installation requirements.

**perché nanus poli**  
*why nanus poli*

- **because** is almost the smaller magnetic contact in the market
- **because** it includes the most advanced Wireless Technology, 868 MHz, completely bi-directional, professional and reliable.
- **because** it integrates the DPMS Technology (Dynamic Power Management System) which allows less interferences and extends the battery life.
- **because** in case of MULTI-RECEIVER system it is able to automatically choose the best radio path.
- **because** it integrates a solid-state Reed sensor and not a mechanically more fragile glass component.
- **because** it has a unique aesthetic - minimalist and discreet different from the rest, being the result of many accurate studies and shapes developed around the battery volume.
- **because** in addition to the white and brown it is available also in gray for installations on stainless steel and aluminium frames.



# velum wls

## Outdoor Curtain Motion Detector

product code **KSI5402010.303** - velum wls DT AM

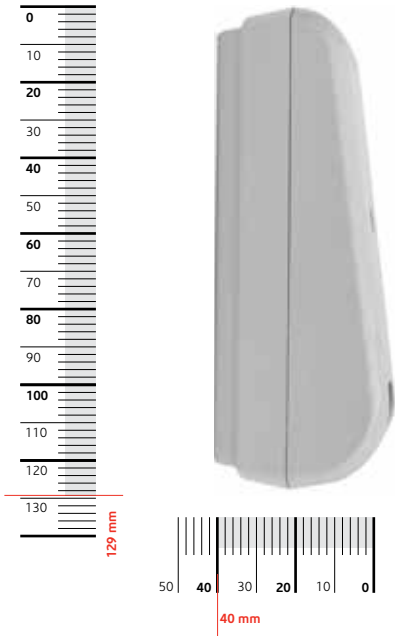

*velum* deriva dal latino e significa *velo*.  
*velum* derives from Latin and means *veil*.

Outdoor curtain velum wls detector is the ideal solution to protect situations such as canopies, porches, below balcony, windows etc. The sensor velum wls is synonymous with reliability and high safety, not only from the qualitative point of view, but also against sabotage attempts, given that integrates a station with accelerometer for wall tamper, flexible and functional even in installations with the bracket and a micro switch for front opening.

The wireless technology used is of the latest generation, fully bi-directional (each device acts as transceiver allowing every transmission to receive a confirmation message, obtaining optimization of consumption and improved reliability compared to traditional mono-directional systems), at 868 MHz frequency band (with FSK modulation).

A sophisticated proprietary control of power transmission (DPMS - Dynamic Power Management System) allows to reduce interference, maximize battery life and optimize the transmission power depending on the distance between the devices and the type of installation.

Maximum protection of the entire system is ensured via encryption of each packet communication, using proprietary algorithm. All wireless devices have a unique serial number that is automatically acquired by the system during installation; both on the programming software and on the keyboard of the ergo series are indicated in real time the signal level of each device and the communication path if there are more BUS receivers or any repeaters.

### TECHNICAL DATA

- **Power Supply:** 1 Lithium battery LS14250 3.6 V (½ AA-size) included for a maximum duration of at least 2 years
- **IR sensor:** dual element
- **IR range:** 12 m (room temperature 25 ° C)
- **Warm-up time:** 60 sec
- **Operating Frequency:** 24.125 GHz
- **Range MW:** from 0.30m to 12m
- **ANTIMASKING Analysis:** active; infrared LED
- **Thornproof:** mems platform (Accelerometer)
- **Sabotage:** front microswitch
- **Operating Temperature Range:** from -20°C to +55°C
- **Operating wireless frequency:** 868 MHz band
- **Sight range:** up to 300m
- **Detection area:** only a tent (angle 7.5 °)
- **Horizontal coverage:** IR 90 °, 80 ° MW
- **Vertical coverage:** IR 7.5 °, 32 ° MW
- **Amplitude tent:** a 2 m 25 cm, 130 cm at 10 m
- **Installation height:** 2.10 m from 2.30 max on the wall
- **weigh:** 90 g
- **protection:** IP54
- **Color:** gray

### HOW TO ORDER

- **KSI5402010.303** - velum wls

### ACCESSORIES

- **KSI5900003.003** - Rain protection\*
- **KSI7203627.000** - Lithium Battery 3.6V (½ AA-size) Included

*\*velum motion detector can be also installed using its protective rain protection hood*

### COMPLIANCE

Europe - CE, RoHS  
 EAC



Motion detectors velum are under 5 year warranty (3+2)

### Diagram of visual coverage

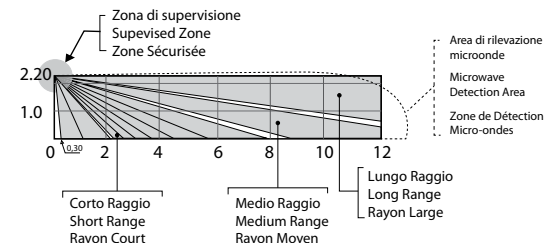

### Range

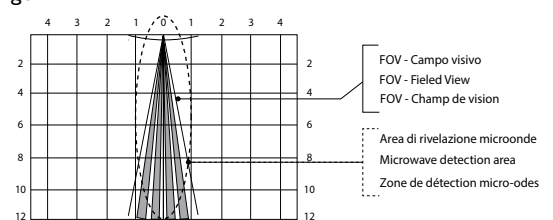



# velum-C wls DT AM

## Outdoor Curtain Motion Detector

product code **KSI5402011.303** - velum-C wls



### TECHNICAL DATA

- **Power supply:** 1 battery pack 3,6 V - 2,7Ah included for a maximum duration of at least 2 years
- **Range:** 6 m (room temperature 25°C)
- **IR sensor:** Dual element
- **Operating frequency uW:** 24.125 GHz
- **ANTIMASKING Analysis:** active infrared LED
- **Thornproof:** Accelerometer
- **Sabotage:** front microswitch
- **Operating temperature range:** from -20°C to +55° C
- **Operating wireless frequency:** 868 MHz band
- **Sight range:** up to 300 m
- **Detection area:** only a tent (angle from 7,5°)
- **Vertical coverage:** IR 90°, MW 80°
- **Installation height:** from 2 to 6 m on the wall
- **Dimension:** 129 x 38 x 40 mm
- **Weigh:** 90 g
- **Protection:** IP 54
- **Color:** gray

### HOW TO ORDER

- **KSI5402011.303** - velum-C wls

### ACCESSORIES

- **KSI7203627.000** - Lithium battery pack 3.6V-2700mA/h

### FUNCTIONS

velum-C wls detector is a curtain motion detector that has the same main characteristics as velum wls detector; it can however be installed on the ceiling with a 6m vertical flow.

In this way, positioned at the center of the frame, it ensures its complete coverage, creating an insurmountable barrier to any intruder.

Diagram of visual coverage

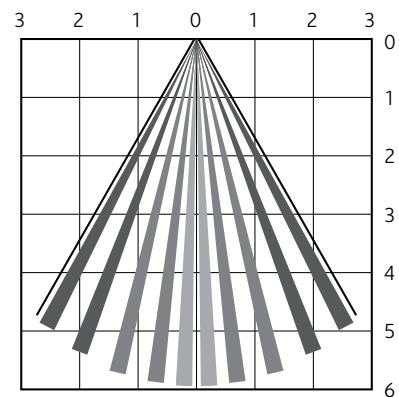

# matrix Universal Transmitter

codice prodotto **KSI5003001.300** - matrix



## TECHNICAL DATA

- **Power supply:** from 1 to 3 lithium batteries CR-123A
- **Operating frequency:** 868MHz
- **Inputs:** nr.1 NC - NA type alarm  
nr.1 NC type sabotage
- **Range in open air:** up to 300m
- **Operative Temperature Range:** -10° +55°
- **Humidity:** 95%
- **Dimensions:** 100 x 43 x 17 mm

## PARTS INCLUDED

- 1 matrix module (PCBA)
- 1 cable for connecting OPTEX motion detectors
- 1 Installation Manual IT / EN / FR

## HOW TO ORDER

- **KSI5003001.300** - matrix module

## COMPLIANCE

Europe - CE, RoHS

## FUNCTIONS

**matrix** module is a bi-directional universal radio interface for connecting third-party low power consumption motion detectors to the lares 4.0 platform, at 868 MHz frequency band.

**matrix** directly feeds the connected motion detector with its own standard CR 123A batteries, from 1 to 3 batteries (second and third are optional) dependently on the consumption of the connected motion detector. Through the supervision function which consists of periodic bi-directional communications between lares 4.0 control panel and wireless devices, the control panel verifies the persistence of the radio communication with all the wireless devices.

Two dedicated inputs (alarm and sabotage) detect any disappearance and / or sabotage of the connected detector. **matrix** itself has a tamper protection vibration sensor (accelerometer), which allows, for example if it is mounted on a joint, to detect even a simple rotation or change of position.

The technology implemented makes it possible to transform any type of detector at low power consumption in a wireless detector by exploiting

the above-mentioned inputs. Specifically speaking about the **OPTEX** sensors, the exchange of data between matrix interface and OPTEX detector takes place via a serial link, by connecting the matrix serial port with the OPTEX serial port through the cable supplied. Thanks to this serial link connection, installers avoid the wiring on the terminal board and the switch manual settings of OPTEX.

### Perché **matrix** why **matrix**

- **Because** it transforms any type of low power consumption motion detectors in a wireless detector;
- **Because** it is the perfect complement of OPTEX series sensors BXS, VXS, WXI, WXS and QXI as it allows remote management (configuration and detailed alarm signalling);
- **Because** it is supplied up to 3 standard CR-123A lithium batteries, able to provide autonomy up to 4500 mAh, to give the user more autonomy in a shorter time, optimizing the replacement time of them.



## OPTEX

to connect OPTEX BXS, VXS, WXI, WXS and QXI motion detectors

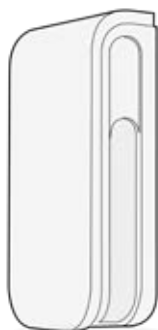

## Universal

to connect third-party motion detectors



The OPTEX sensor configuration can also be performed via any mobile device through APP Ksenia PRO or Ksenia SecureWeb. Whereas, for connecting all the other sensors to matrix, the electrical wiring to the PCBA terminal board is required.

For OPTEX sensors of series:

- **BXS** (Radio/Antimasking/PIR and high sensibility to PIR right side and left side);
- **VXS** (Radio/Antimasking/PIR and Microwave multidirectional/coverage 90°);
- **WXI** (Radio/Antimasking/PIR and right side and left side/coverage 180°);
- **WXS** (Radio/Antimasking/PIR and Microwave right side and left side/coverage 180°);
- **QXI** (Radio/PIR and Microwave multidirectional/coverage 120°);

a programming session has been explicitly developed within the configuration program of the lares 4.0 platform, starting from the **matrix** module configuration.

In fact, starting from Ksenia configuration program, it is possible to customize the type of functioning requested to the wireless matrix sensor, choosing between **Universal** type operation (to connect third-party motion detectors) or **OPTEX** type (to connect OPTEX series BXS, VXS, WXI, WXS and QXI motion detectors).

In case of Universal operation, customization is limited to general information about **matrix** (serial number, supervision and tamper protection) while, in the case of OPTEX operation, the customization is extended to the model of the connected OPTEX sensor. In addition to the general information written above, the configuration of the functioning is required (enable/disable: PIR sensor, tamper/accelerometer, switch configuration hardware on board, alarm notification with LED, inhibition time, anti-masking), PIR settings (PIR sensitivity and PIR pulse number), micro-wave settings (micro-wave sensitivity and micro-wave immunity), etc.

# imago wls Outdoor Siren

product code **KSI6401000.3XX** - imago wls, different colors



58

WIRELESS TECHNOLOGY / imago wls



## TECHNICAL DATA

- Modern Design with original and convenient rotating opening
- Solid PC housing (minimum thickness 3 mm.) with anti-UV pigment
- Front available in different colors
- Transparent base available in different colors: orange, red and blue
- Strong metallic zinc-plated under-cover (anti-smashing)
- High acoustic power piezoelectric Buzzer (>100dBA @ 1m)
- Protective and insulating treatment of the PCB (conformal coating)
- Power Supply: 9V(min.) - 13.8V (max – power supply not included)
- **Rechargeable Backup battery: 6Vdc – 1,2Ah (not included)**
- **Un-rechargeable Main battery: 7,5Vdc – 8Ah non-reloadable (not included)**
- Operative temperature range: -10° +55°C 95% humidity
- Protection class: IP43
- Dimensions: 195 x 330 x 60 mm
- Weight (without battery): Kg 1.200
- Wireless bi-directional communication; 868MHz frequency

The imago wireless outdoor siren is a wireless acoustic and optical sounder. Thanks to its cutting-edge technology, it guarantees high performance with maximum energy savings and consequent optimization of consumptions. It is equipped with high sound pressure, a 1W power LED alarm light and two LEDs for auxiliary signaling. The siren is handled by two synchronized microcontrollers: one deals with major processing, in order to verify all conditions and to perform all required actions; the other for the RF communication channel management (bi-directional) and for receiving commands, sending alerts, diagnostic and so on.

imago wireless gives the opportunity of choosing two power modes: via proprietary non-rechargeable 7.5V 8Ah, alkaline battery pack (which must be replaced upon discharge); or via external power supply (12Vdc), with rechargeable lead-acid 6V 1.2Ah battery, to be made with optional components (battery and possibly power supply). The battery is constantly monitored, and its failure or discharge is immediately reported to the control panel.

imago wireless is equipped with a temperature sensor providing the value of the temperature detected and the exceeding of any thresholds set, through signals on the RF channel.

In addition, it also has protections:

- For the connection on the RF channel: it must periodically communicate its status to the system in which it is configured. Failure to communicate it, can generate an alarm event.
- For the open of the plastic case or the attempt to remove it from the wall: the device monitors the microswitches provided for this feature and, if these change their status when the plastic case is opened or removed from the wall, it will promptly notify the change.

imago wireless is a bidirectional wireless device, each signaling sent to the relevant system requires an effective feedback and, if this is not received (for any reasons), the device repeats the signal. This contributes to significantly increase the reliability of the device in communications.

Despite its extremely small size, imago wireless hides a solid, shatterproof metal under-cover inside made of high-quality polycarbonate, in order to guarantee its resistance over time.

- RF Range: 300 m. in open air
- Supervision for wireless diagnostic (programmable)
- Temperature sensor (excludible)
- Temperature thresholds managing (programmable)
- Management of the maximum duration of the alarm (programmable)
- Alarm output configurable as Bistable or Monostable
- Power LED output configurable as Bistable or Monostable
- Auxiliary LED output configurable as Bistable or Monostable
- Acoustic signals of RF level OK

#### PARTS INCLUDED

- 1 Siren complete with PCBA and metal undercover
- Sets 6 mm Dia. Bolts & Nuts
- Installation manual

#### OPTIONALS

- KSI7207580.000 - Alkaline battery 7,5V/8Ah non-rechargeable

#### COMPLIANCE

Europe - RoHS, CE  
EAC



#### HOW TO ORDER

Ksenia finished product:

- KSI6401000.3XX\* - imago wls

(\*) The code suffix 3XX indicates the different color option.  
e.g. 318 Is the code for a white cover with red bottom imago.

#### Available colors codes

##### Covers



1    3    50    60    70

##### Bottom



7    8    9



Alkaline battery pack

# duo BUS BUS Transceiver / Repeater

product code **KS12600000.310** - for KS-BUS only



60

WIRELESS TECHNOLOGY / duo BUS

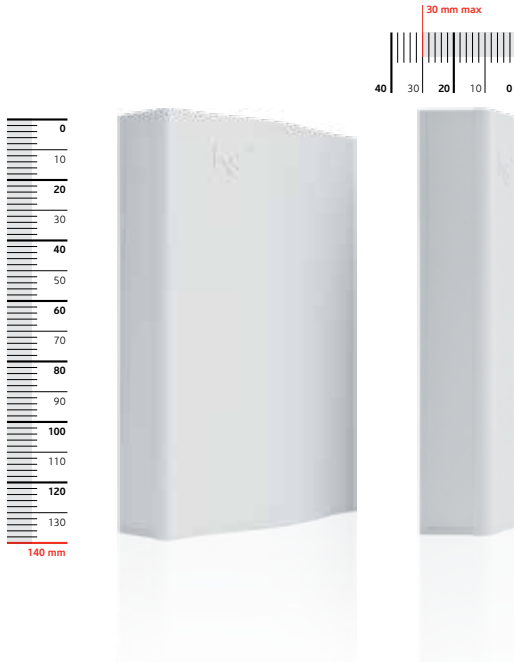

## TECHNICAL DATA

- **Power:** 13,8 Vdc
- **Consumption:** max. 50mA
- **Operative Frequency:** 868 MHz Band
- **Range in open air:** up to 400 m
- **Max. WLS Device Nr.:** 64
- **I/O Terminals:** 2
- **Wireless Zones:** max. 128
- **Operative Temperature:** +5°C to +40 °C
- **Dimensions:** 140 x 100 x 28 mm (L x H x P)

## PARTS INCLUDED

- 1 Transceiver / Repeater duo (PCBA)
- 1 Slim Case with screw
- 1 Quick Installation Guide

## HOW TO ORDER

- **KS12600000.310** - KS-BUS Version

## ACCESSORI

- **KS17207008.000** - Lithium-Ion Battery 7,4 Vdc-850 mAh
- **KS17302000.010** - Plastic box "slim" version

## CERTIFICATIONS

Europe - RoHS, CE  
EAC  
EN50131 grade 2 - Class II  
T031:2014  
SSF 1014 Larmklass R



**duo** deriva dal latino e significa **doppio**.  
*duo derives from Latin means double.*

Each **duo BUS** version enables to expand any Control Panel of the lares series by giving the opportunity to link up to 64 wireless Devices for a total of max. 128 wireless zones and up to 20 remote controls. On the same BUS it is possible to link up to 2 transceivers for both expanding the wireless signal coverage and for acting contemporary as a back-up of the other.

**duo** can also work as a Signal Repeater simply powering it up.



duo board in the slim plastic case

**Perché duo**  
*why duo*

- **because** it can work both in Transceiver mode (wired on KS-BUS or in Repeater mode (simply powering it up it extends the signal range).
- **because** it integrates the MULTI-RECEIVER technology, i.e. up to 2 devices and 2 repeaters can be included in the same Architecture.
- **because** in case of MULTI-RECEIVER system, the connected wireless devices are able to automatically choose the best radio path.
- **because** the REPEATER needs to be connected only to the +12Vdc, not to the BUS and it can integrate a Lithium-Ion battery which in case of black-out is able to guarantee at least 12 continuous hours coverage.
- **because** it can manage up to 64 wireless devices and max 128 wireless zones.

# universal duo Transceiver / Repeater

product code **KS12600001.310** - universal duo



## TECHNICAL DATA

- **Power:** 13,8 Vdc
- **Consumption:** max 50mA
- **Operative Frequency:** 868 MHz Band
- **Range in open air:** up to 400 m
- **Max. WLS Device Nr.:** 32 Devices
- **Wireless Zones:** max 96
- **Operative Temperature:** +5°C to +40°C\
- **Dimensions:** 140 x 100 x 28 mm (L x H x P)

## PARTS INCLUDED

- 1 Transceiver / Repeater universal duo
- 1 Slim Case with screw
- 1 Quick Installation Guide

## HOW TO ORDER

- **KS12600001.310** - universal duo

## COMPLIANCE

Europe - RoHS, CE

## FUNCTIONS

The bi-directional universal receiver duo univ allows the use of wireless peripherals of Ksenia Security with any control panel or similar devices: this installation is possible thanks to 8 programmable outputs available on the device. The number of outputs can be increased up to 18 using auxi or auxi-relay modules.

## MAIN FEATURES

- Up to 18 programmable outputs: 8 outputs on the duo univ, up to 2 expansion modules auxi/auxi relay, each with 5 programmable outputs.
- Up to 32 wireless configurable sensors (poli, nanus poli, unum wls, nebula)
- Configurable with up to 8 opera remote controls which activate specific outputs or change the system status (armed, disarmed, partially armed)
- Up to 15 groups (partitions) to be associated with one or more of the wireless sensors enrolled to the system, each group is linked to a specific output
- System programming and monitor via LCD ergo Keypad
- Multi-language programming menu
- Configuration data stored in non-volatile memory
- 3 Status LEDs



duo board in the slim plastic case

# nebula optical smoke detectors

product code KSF5100001.001 - glass design, wired  
KSF5100001.003 - mesh design, wired  
KSF5300001.001 - glass design, stand-alone  
KSF5300001.003 - mesh design, stand-alone



62

WIRELESS TECHNOLOGY / nebula



Detail of separate bases

**nebula** deriva dal latino e significa nuvola, nebbia.  
**nebula** derives from Latin means cloud, fog.

**nebula** detectors are optical devices that allows a very quick smoke and fire detection respecting DIN EN 54-7 normative (wired version) or EN14604:2005 (stand-alone version).

Both models are fitted with a separate base available in silver and white. Thanks to the handy bayonet the installation is completed by screwing the detector on the base. There are two versions: the first with silver mesh, the second with circular glass design. Both versions of the device have a red LED for alarm event.

All models are also available in wired version, extremely practice in cabling thanks to the separate base.

## TECHNICAL DATA

- **Operating temperature range:**  
-10 to +60 °C, 95% Humidity
- **Weight:** 320 g (glass design)  
160 g (mesh design)
- **Dimensions:** 112x37 mm (glass design)  
95x21 mm (mesh design)

## Stand-alone versions

- **Power Supply:** 9V battery  
for a life expectancy up to 10 years

## Wired versions

- **Operative range:** 9 - 33 Vdc
- **Consumption:** < 20 µA - 25mA max

## PARTS INCLUDED

- 1 nebula Optical smoke detector
- 1 Separate base
- 1 9V Battery (only wireless version)
- 1 Installation manual

## HOW TO ORDER

- **KSF5100001.001** - nebula glass design, wired version
- **KSF5100001.003** - nebula mesh design, wired version
- **KSF5300001.001** - nebula glass design, stand-alone version
- **KSF5300001.003** - nebula mesh design, stand-alone version

## CERTIFICATIONS

EAC  
EN14604:2005 - stand-alone version  
EN54-7 - wired version



## Radio interface for stand-alone smoke detectors

product code **KSI5003000.300**



## TECHNICAL DATA

- **Operative range in open air:** up to 350 m
- **Battery life expectancy:** up to 2 years

**HOW TO ORDER**  
**KSI5003000.300**

**COMPLIANCE**  
Europe - CE  
EAC



The radio interface allows to enroll the nebula stand-alone detectors to lares systems.





# USER INTERFACES



ergo-T.....	66
ergo-T plus .....	67
ergo S .....	68
ergo.....	69
ergo M .....	70
volo .....	72
volo-in .....	73



TOUCH SCREEN



CAP SENSE



DESIGN



COMPLETE SYSTEM  
MANAGEMENT



REMOTE LISTENING  
FUNCTION

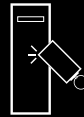

EASY TO USE

# ergo-T touchscreen Keypad

product code KSI2100040.302 - ergo-T



## TECHNICAL DATA

**IP interface:** PoE - 13W max  
**Power supply:** 10 -15Vdc, 700mA max  
**Display Capacitive Touch:** 7" TFT  
**Resolution:** 1920x1200 (FHD)  
**Dimensions:** 187x110x 34 mm  
**CPU:** Rockchip 3368 Octacore  
**GPU:** Mali-400MP GPU  
**Operating System:** Android 7.0  
**RAM:** 2 GB  
**Nand Flash:** 8 GB  
**SD Card Slot:** max 32 GB

## PARTS INCLUDED

1 ergo-T keypad  
1 attachment bracket  
2 screws for DIN 503 box

## HOW TO ORDER

• KSI2100040.302 - ergo-T

## COMPLIANCE

Europe CE - RoHS  
EAC



*ergo deriva dal latino e significa ebbene, allora, dunque.  
ergo derives from Latin and means then, therefore, at last.*

**ergo-T and ergo-T plus** are the touchscreen keypads of latest generation, the ideal command and control interface of lares 4.0 control panels.

Unlike all the typical touchscreen products of the Security market, ergo-T and ergo-T plus differ in a contrast and a resolution comparable to the end-user device ones, thus closer to the everyday end-user experience.

They do not communicate to the panel via BUS, they use the network port instead. In this way, not only is it possible to manage all the various functions related to Intrusion Security, but also the functions of Video verification, Access Control, up to what is today defined as Home Automation or Smart Home in general (i.e. management of the various automations, lights, temperatures, motorized shutters, appliances, irrigation, etc.).

Even though they use the network port, ergo-T and ergo-T plus are recognized by the control panel with a fast acquisition process with no need of any configuration on the router; furthermore, they can be supervised by the panel like a normal keypad on BUS.

**ergo-T and ergo-T plus** have a graphic interface in line with lares 4.0 mobile application: this guarantees the same user experience to the end-user, during the local or remote management of the control panel.

They are easily customizable by the user both in the theme (light or dark) and in the use of 6 favourite commands which can be directly added in the dashboard.

Moreover, they comply with any need of installations: in residential environments, they can be used to get access to all Smart Home functions without the need to enter the PIN code, that is required only

for the activities related to Security; in commercial environments, they can be used in protected mode, therefore it is possible to surf through the various available functions only entering a valid user PIN.

**ergo-T and ergo-T plus** are ideally positioned in any round wall-mounting box (60 mm pitch) or DIN 503 and can be powered with 12V or with PoE (Power over Ethernet).

The keypads are available in 7" (ergo-T) and 10" (ergo-T plus) size.

### *Perché ergo-T & ergo-T plus why ergo-T & ergo-T plus*

- **because** they have a resolution of 1920x1200 pixels both in 7" and 10" size;
- **because** they allow to manage the control panel safety with a user experience that is very similar to that of mobile app;
- **because** they have a customizable graphic interface both in theme and in the 6 favourite functions;
- **because** they allow to see the cameras connected to the system without the need of additional devices;
- **because** they make you choose the stand-by setting mode: fixed or when the system will be armed;
- **because** they make you manage all Smart Home functions comfortably;
- **because** they can be powered both with 12V and PoE port.

# ergo-T plus touchscreen Keypad

product code KSI2100041.302 - ergo-T plus



## TECHNICAL DATA

**IP interface:** PoE - 13W max  
**Power supply:** 10 - 15Vdc, 700mA max  
**Display Capacitive Touch:** 10" TFT  
**Resolution:** 1920x1200 (FHD)  
**Dimensions:** 243 x 172 x 34 mm  
**CPU:** Rockchip 3368 Octa core  
**GPU:** Mali-400MP GPU  
**Operating System:** Android 7.0  
**RAM:** 2 GB  
**Nand Flash:** 8 GB  
**SD Card Slot:** max 32 GB

## PARTS INCLUDED

1 ergo-T plus keypad  
1 attachment bracket  
2 screws for DIN 503 box

## HOW TO ORDER

• KSI2100041.302 - ergo-T plus

## COMPLIANCE

Europe CE - RoHS  
EAC



- ① Power supply 13,8 Vdc
- ② 10/100 T + PoE ethernet connection
- ③ Fastening
- ④ Fastening plate for DIN 503 and round (pitch 60 mm) boxes
- ⑤ Fixing screws



# ergo S CapSense keypad

Product Code **KS12100020.301** - ergo S white  
**KS12100020.302** - ergo S black



## TECHNICAL DATA

- **Wide Dot matrix LCD display:** viewing area 79 x 19 mm
- **Keys in Capsense Technology:** no mechanical press-buttons
- **Circular Scroll:** fast access to the menu
- Available in The Ksenia colors black and white
- **Proximity reader RFID**
- **Integrated Microphone and Speaker**
- **Remote listening function**
- **Accurate Temperature sensor**
- **Adjusting backlight and contrast**
- **Fast Addressing System:** no need to pre-set the device address (automatic recognition from the control panel / GSM communicator)
- **Master programming for gemino and duo universal**

NOTE: Hardware includes a NFC Ready transceiver. You may need to use a dedicated application. (NOT INCLUDED)

## HOW TO ORDER

- **KS12100020.301** - ergo S white
- **KS12100020.302** - ergo S black

## CERTIFICATIONS

Europe - CE, RoHS

EAC

EN50131 grade 3 - class II

T031:2014

SSF 1014 Larmklass 3



Isn't this the Keypad we were all waiting for?

Finally, a clear and simple Keypad, beautiful and useful also as programming tool, it incorporates a proxy reader, with no mechanical parts, versatile, modern, thin (less than 13 mm), it can be placed in every interior design.

An extremely versatile Keypad, suitable for any type of architecture, with a clean, simple and minimalist style.

The Keypad, characterized by a larger graphic display and easy to read, boasts a type of advanced use, thanks to CapSense Technology which does not provide any mechanical key, preferring a delicate tactile sensitivity.

The ergo S is synonymous with innovation, beauty and attention to detail, without neglecting the strong functional component: it allows you to view the System status, the operating parameters, control the whole System, and much more.

Moreover, it also allows to program the GSM communicator with extreme rapidity and simplicity.

The Keypad is available in two colors, white or black, with a glossy and modern finish.

## MAIN FUNCTIONS

- **Display of System status**
- **Display of operating parameters:** date / time, GSM network active level GSM, etc.
- **System Commands:** complete or partial arming, reset, activation of output terminals, telephone calls, etc.
- **Full Programming of System Parameters / Central**
- **Programming local parameters:** audio volume, backlight level and LCD contrast
- **keyboard functionality Exclusion for front cleaning purposes**
- **Remote Listening**
- **Voice messages recording**
- **RFID Tag** reading to arm, and disarm and manage lares devices
- **High Precision** temperature sensor.

# Keypad ergo

Product Code KS12100000.300 - ergo



## TECHNICAL DATA

- LCD Display 16x2 (visible area 61x16mm)
- "CapSense" Technology (no mechanical press-buttons)
- Circular Scroll / quick menu access
- Available in 4 different colors
- RFID Proximity Reader
- Integrated Microphone and Speaker for remote listening
- "Fast Addressing System" no need to pre-set the device address (automatic recognition from the Control Panel/GSM Communicator)
- 2 programmable inputs/outputs
- Display of system status
- Display of functioning parameters: date/time, active GSM network, GSM level, etc
- System commands: complete or partial arming, reset, activation of outputs terminals, phone calls, etc.
- Programming of system parameters
- Programming of local parameters (audio volume, backlight levels)
- KP functionality exclusion for front cleaning purposes
- Temperature sensor
- Remote listening function

## CERTIFICATIONS

Europe - CE, RoHS,  
EN50131 Grado 3 - Classe II  
T031:2014  
SSF 1014 Larmklass 3



Isn't this the Keypad we were all waiting for?

## CAPSENSE Keypad

ergo is a very advanced LCD Keypad carefully developed with the objective to capture a modern, minimalist and discreet style and an extremely slim profile (less than 1/2 inch.), which allows it to be positioned in any interior architecture thus expressing a new feeling of design, prestige and innovation.

Thanks to the "CapSense" Technology, here you won't see any of the ugly mechanical parts (like as membranes, buttons, plastic cover, etc.) which are typically available in other products and that are often the ideal dust location and the source of bad contacts. In the case of ergo the front is completely smooth and all desired functions can be implemented by simply touching upon the surface in the areas shown by the graphic (letters, symbols, circular-scroll mouse) in a very simple and rational manner.

It can be customized in the 4 different Ksenia colours (White, Black, Red and metallic Grey), simply by removing the transparent cover and interchanging the internal cover (Lexan) with one of those included in the package envelope, such operation is meant to be so easy and safe that can be done by the end-user at any time. Moreover, with no need of additional parts, it can be "flush-mounted" taking advantage of any std. box DIN 503, or just as it is on any wall (with no need of additional parts) or if desired even the desk-solution can be chosen thanks to the included stylish sustainer parts.

The ergo Keypad has been conceived not only to be linked to a Ksenia Intrusion Control Panel, but even to the Universal GSM/GPRS Communicator gemino, since, differently to other similar devices, it works also as "programming unit", making the installer's life much easier by avoiding the need of having a PC with for the Communicator programming.

## HOW TO ORDER

KS12100000.300 - ergo keypad



# ergo M mechanical Keypad

Product Code KSI2100021.311 - ergo M White  
KSI2100021.312 - ergo M Black



## MAIN FEATURES

- Display LCD dot matrix (visible area 79×19 mm)
- Mechanical press-buttons (laser-routed)
- Available in The Ksenia colors black, white
- Integrated Speaker
- Adjust backlight and contrast
- Fast Addressing System: no need to pre-set the device address (automatic recognition from the Control Panel/GSM Communicator)
- Master to programming for gemino and universal duo
- Display of System status
- Display of operating parameters: date / time, GSM network active level GSM, etc.)
- RFID Tag reading to arm and disarm the intrusion detection systems set up with the lares 4.0 devices.
- System Commands: complete or partial arming, reset, activation of output terminals, telephone calls, etc.
- Full Programming of System Parameters / Panel
- Programming local parameters: audio volume, backlight level and LCD contrast
- Voice messages recording

## HOW TO ORDER

- KSI2100021.311 - ergo M White
- KSI2100021.312 - ergo M Black

## CERTIFICATIONS

Europe - CE, RoHS  
EAC  
EN50131 Grade 3 - Class II  
T031:2014



The **ergo M** keypad has the same simple and minimalist design and an extremely slim profile as the ergo S, and unlike the latter, it provides a mechanical press-buttons (laser-routed keyboard)

The **ergo M** integrates the RFID Tag reader to arm and disarm the intrusion systems or, more generally, to arm scenarios, activated with the lares 4.0 series devices. The use of a new plastic material allows a better tactile perception and increases its strength.

## MECHANICAL KEYPAD

The **ergo M** Keypad has been conceived not only to be linked to a Ksenia Intrusion Control Panel, but even to the Universal GSM/GPRS Communicator **gemino**, since, differently to other similar devices, it works also as “programming unit”, making the installer’s life much easier by avoiding the need of having a PC with for the Communicator programming.

**ergo M** is laser-routed and mounts high quality switches to improve reliability.

We designed a custom display for having a large display area, and adjustable contrast and backlight. This display can show all character sets, including the Greek and Cyrillic, because of dot matrix technology. The total thickness of the devices is of only 14.5 mm.

ergo M are both available in White and Black.

## Perché ergo M why ergo M

- **because** is a very advanced LCD Keypad carefully developed with the objective to capture a modern, minimalist and discreet style as well as an extremely slim profile (less than ½ inch.), which allows it to be positioned in any interior architecture thus expressing a new feeling of design, prestige and innovation;
- **because** with no need of additional parts, it can be “flushmounted” taking advantage to any std. box DIN 503, or just as it is on any wall (with no need of additional parts);
- **because** it can be used also to program the gemino GSM/GPRS Communicator and to record “personalized” messages to be associated to any alarm event;
- **because** it uses cutting edge Technologies components, such as a digital mems (accelerometer) microphone.



# ergo Keypads

simple and minimalist design  
suitable for any type of architecture



# Outdoor proximity reader **volo**

product code **KS12200000.300** - volo black  
**KS12200000.310** - volo white

72

USER INTERFACES / volo



## MAIN FEATURES

- Power Supply: 13.8 Vdc
- Consumption: 40mA
- RFID: ISO 14443 (A+B) @ 13.56MHz
- Dimensions: 127x43x17 mm

## PROGRAMMING

volo can be connected to the 4-wires KS-BUS and can be programmed directly from the Control Panel.

## CERTIFICATIONS

Europe - CE, RoHS  
EAC  
EN50131 Grade 3 - Class II  
T031:2014  
SSF 1014 Larmklass 3



**volo deriva dal latino e significa volare, muoversi rapidamente.**  
**volo derives from Latin and means fly, move quickly.**

**volo**, linked on the KS-BUS, allows the user to manage to manage the arming /disarming of the Ksenia Security System and more in general the activation/ deactivation of different scenarios programmed in terms of Home Integration, by means of mini-Tags. It can be installed either directly onto the wall (in vertical) or screwed onto the Box DIN 503 (with an optional black frame).

The device is provided with 5-color LED (red, green, blue, yellow, white) and each of them can be associated to a customizable scenario. It is very simple to activate a scenario: approaching a valid Tag or NFC-enabled Phone to the Proxy Reader, the LED will switch on the color associated to the possible scenario, proposing automatically the most probable choice at first. To activate the desired scenario take the Tag or the Phone away when the LED is lit of the color related to that scenario: as acknowledge the LED will remain ON with the same color for other 3 seconds.

Its sober design allows the volo to be installed in every interior design. This device has been developed with an innovative tamper protection (against wall removal and opening): an accelerometer. This allows to avoid any mechanical switch and the related risk of deterioration, moist infiltration in Outdoor and to use it as a seismic detector with programmable sensitivity. Its plastic enclosure and the PCB protection treatment (full immersion in epoxy resin) allow its Outdoor Installation without additional protection.

## PARTS INCLUDED

- volo proximity reader with a 2 meters long cable
- Quick Installation Guide
- 2 Fischer screws, diameter 5mm.

## HOW TO ORDER

- **KS1220000.300** - volo black
- **KS1220000.310** - volo white

## ACCESSORIES

- **KS12200001.300** - Optional frame for DIN 503 mounting. Color black
- **KS12200001.310** - Optional frame for DIN 503 mounting. Color white
- **KS17600000.000** - Mini-Tag in black color with metal key-holder ring.



Pocket Mini-Tag



# Indoor proximity reader **volo-in**

product code **KS12200002.300** - volo-in

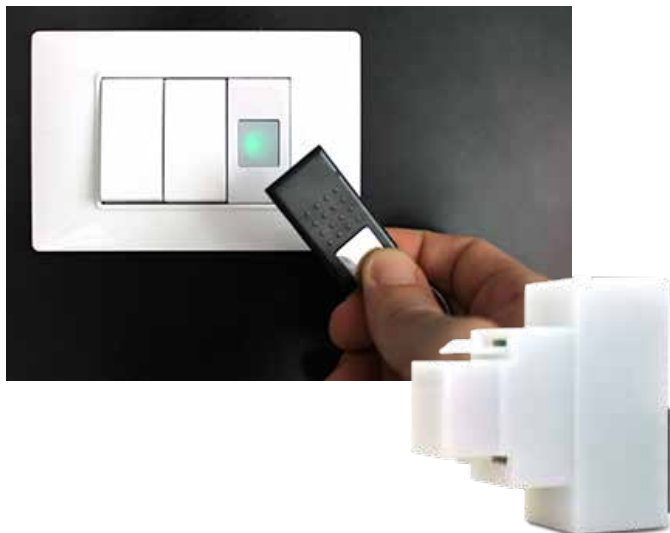

## MAIN FEATURES

- Power Supply: 13.8 Vdc
- Consumption: 10mA
- RFID: ISO 14443 (A+B) @ 13.56MHz
- Dimensions: 45x43x17 mm

## PROGRAMMING

**volo-in** can be connected to the 4-wires KS-BUS and can be programmed directly from the Control Panel.

## CERTIFICATIONS

Europe - CE  
EAC  
EN50131 Grade 3 - Class II  
T031:2017



Scenarios identification multicolor LED: ○ ● ● ● ● ●

## MAIN FUNCTIONS

**volo-in** is a proximity reader with RFID Technology.

**volo-in** is a proximity reader for indoor with acoustic/light signals, directly connected to the Ksenia BUS, the management of an entry / disarm the system intrusion Ksenia Security or, more generally, the activation / deactivation of Nr. 5 scenarios programmed in optical automation, using the approach of the mini-tags enabled.

The device uses the standard slot RJ45 jack to be added to any provision of any supplier of devices housed in standard box 503.

The device has a multi-color LED (red, green, blue, yellow, white) which can be associated with a scenario freely programmable. It is very easy to activate a scenario: just bring a valid key to the reader, wait until the feedback (LED light of the scenario turns on), and remove the key.

It is possible to assign different acoustic tone to all the operations to deal with unusual light conditions and also to help visual impaired users

**volo-in** is equipped with a multi-tone buzzer to confirm the operations. To make it UNIVERSAL for all major plates, **volo-in** takes advantage from the standard square profile socket arising from the RJ45 Keystone socket used in a standard patch panel and other items of equipment. As such, the RJ45 flush socket will fit a standard pattern wall plate, normally designed for light switches from several manufacturers.

## PARTS INCLUDED

- volo-in proximity reader
- Quick Installation Guide
- 2 Fischer screws, diameter 5mm
- 2 mini-TAG Ksenia

## HOW TO ORDER

- **KS12200002.300** - volo-in

## ACCESSORIES

- **KS17600000.000** - Pocket Mini-Tag in Black color with metal key-holder ring.



Pocket Mini-Tag



# BUS PERIPHERALS



auxi 10.....	76
auxi .....	77
matrix BUS .....	78
auxi relé.....	79
divide .....	80
BUS HUB .....	81
opis.....	81

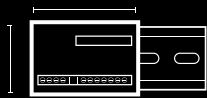

DIMENSIONS FOR  
DIN RAIL



POSSIBILITY TO  
EXPAND THE ZONES



SMART HOME  
ACTIONS



INSTALLATION  
EVEN ON EXISTING  
SYSTEMS

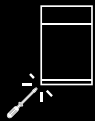

TAMPER  
PROTECTION



ROLLER SHUTTER  
AND VIBRATION  
SENSORS  
MANAGEMENT

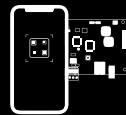

AUTOMATIC  
CONFIGURATION

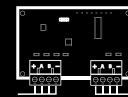

ADDITIONAL BUS  
BRANCHES

# auxi 10in expansion module

product code **KS12300003.300** - auxi 10in PCBA



## TECHNICAL DATA

- **Voltage:** 13,8 Vdc
- **Consumption:** 20 mA (excluding terminal +P1 e +P2)
- **Analog input:** 1 @ 0 – 10V
- **Up to 10 alarm inputs** (programmable EOL)
- **Power terminal:** 2 @ 0,5A (protected by a self-restorable thermal fuse)
- **PCBA dimension:** 45×75×16mm (lxhxp)

## HOW TO ORDER

- **KS12300003.300** - auxi 10in PCBA

## ACCESSORIES

- **KS17300000.001** - Plastic box for DIN rail
- **KS17302000.010** - Plastic box "slim" version

## PARTS INCLUDED

- 1 auxi 10in expansion module (PCBA)
- 4 sustainers for metal cabinet's mounting
- 1 Installation Manual

## CERTIFICATIONS

Europe - CE  
EAC  
EN50131 Grade 3 - Class II  
T031:2014



### Perché auxi 10 why auxi 10

**auxi 10in** is an input expansion module for **lares 4.0** control panel. It was born to offer a solution to increase the number of inputs, in particular on medium/large systems; the result is the dramatically reduction of the number of devices to be connected on the BUS and of the space occupied.

This also means reduction of the time, installation costs and also increasing reliability. The dimensions are extraordinarily compact, the same of traditional auxi device. It is equipped with trolley terminal blocks of the same size of traditional auxi.

#### PROGRAMMING

The programming of the terminal functions is implemented during the programming of **lares 4.0**. **auxi 10** has to be linked to the **lares 4.0** control panel via the KS-BUS. Its 10 terminals can be configured as programmable inputs with End-of-line resistors.

**auxi 10in** can be programmed directly from the **lares 4.0** Control Panel.

- **because** with only one expansion module you can extend the number of input terminals available on your system;
- **because** it is automatically configurable by means of its serial number: no need to adjust dip-switches on board;
- **because** it is very small and therefore can be installed inside the wall within a standard DIN503 box;
- **because** each terminal can be programmed as inputs with different EOL resistors;
- **because** all the terminals can be programmed to directly manage the shutter and inertial sensors, without need for any external analysis card;
- **because** it can be housed in a suitable plastic box for fixing on DIN rail.

# Expansion module **auxi**

product code **KS12300000.300** - PCBA auxi



## TECHNICAL DATA

- **Voltage:** 13,8 Vdc
- **Current consumption:** 20 mA (excluding terminal P and outputs)
- **Analog input 1** @ 0 – 10 V (only with lares Control Panel)
- **Alarm inputs:** Up to 5 (with programmable EOL)
- **Analog output 1** @ 0 – 10 V, 20 mA
- **Open Collector outputs:** Up to 5 da 500mA each
- **Power terminal:** 0,5 A (protected by a self-restorable thermal fuse)
- **PCBA dimension:** 75×45×16 mm (l×h×p)

## PARTS INCLUDED

- 1 auxi expansion module (PCBA)
- 4 sustainers for metal cabinet's mounting
- 1 Installation Manual

## HOW TO ORDER

- **KS12300000.300** - PCBA auxi

## ACCESSORIES

- **KS17300000.001** - Plastic box for DIN rail
- **KS17302000.010** - Plastic box "slim" version

## CERTIFICATIONS

Europe - CE  
EAC  
EN50131 Grade 3 - Class II  
T014:2013  
SSF 1014 Larmklass 3



**auxi** deriva dal latino e significa *crescere, aumentare, potenziare*.  
*auxi derives from Latin and means to increase, to potentiate.*

**auxi** enables to increase up to 5 (or multiples with multiple modules) the numbers of programmable inputs (outputs) of the gemino GSM/GPRS Communicators and of the lares 4.0 integrated Control Panels.

**auxi** configuration into the system is very fast, no need to configure any dip-switches: **auxi** will be automatically acquired by gemino, lares and lares 4.0 and identified univocally with its serial numbers that you can find impressed on the PCBA label.

**Its dimensions allows its insertion within a standard DIN 503 box for wall mounting or alternatively into the plastic "slim" box (Ksenia p/n KS17302000.010).**

## HOW TO PROGRAM

**auxi** is to be linked to **gemino**, **lares** and **lares 4.0** through the 4 wires KS-BUS and has 5 terminals which can be configured as programmable inputs with End-of-Line resistors or OC outputs at 500 mA. One of the five terminals can be configured as 0-10 Vdc analog output. The programming of the terminal functions is implemented during the programming of gemino and lares 4.0 (only output).

**perché auxi**  
*why auxi*

- **because** with the same expansion module you can either increase the number of zones of the Control Panel or increase up to 10 the number of programmable inputs (outputs) of gemino expandable;
- **because** it is automatically and univocally configurable by means of its serial number: forget about having to adjust dip switches or assign addresses to them;
- **because** it is very small and therefore can be installed inside the wall within a standard DIN503 box;
- **because** all its 5 terminals can be programmed as Open Collector outputs up to 500 mA each;
- **because** all its 5 terminals can be programmed as inputs with EOL resistors;
- **because** 1 of its 5 terminals can be programmed as analog input 0-10 Vdc (only for lares Control Panels);
- **because** 1 of its 5 terminals can be programmed as analog output 0-10 Vdc, able to manage the output voltage, which can be use, for example, as a luminous intensity regulator (DIMMER).

# matrix BUS expansion module

product code **KS12300006.300** - matrix BUS

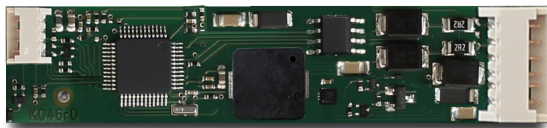

**matrix BUS** is a wired expansion board that gives the opportunity to add zones to the control panel when connected to the Ksenia BUS. It that can operate as UNIVERSAL and, in this case, it adds 1 zone or as OPTEX and, in this case, it adds up to 3 zones, depending on the type of Optex sensor connected.

It also allows to connect any type of sensor to our BUS, with the objective of simplifying and optimizing the wiring: in addition to an input, it has a serial interface useful for connecting with OPTEX sensors. Once connected to the matrix BUS, it is possible to carry out the configuration remotely through Ksenia SecureWeb, or via Ksenia PRO App.

matrix BUS does not require any battery because it is powered by the KS-BUS.

The size is ultra-compact and has a mems is also present.

## TECHNICAL DATA

- **Power supply:** 13,8 VDC
- **Absorption:** 50 mA max.
- **Inputs:** nr.1 type alarm (with programmable EOL)
- **Power terminal:** 0,5 A (protected by a self-restorable thermal fuse)
- **Dimensions:** 114x71,5x8 mm
- **KS-BUS interface**

## PARTS INCLUDED

- 1 expansion module matrix BUS (PCBA)
- double-sided tape for installation
- 1 cable for connecting to the control panel
- 1 cable for connecting OPTEX motion detectors (BXS, VXS, WXI, WXS e QXI)
- 1 Installation Manual IT / EN / FR

## HOW TO ORDER

- **KS12300006.300** - matrix BUS module

## COMPLIANCE

Europe - CE

### Perché **matrix BUS** why **matrix BUS**

- **because** with a single expansion card we can expand the central zones;
- **because** it has a universal entrance that allows the management of the shutters;
- **because** it is powered by BUS;
- **because** it has ultra-compact dimensions;
- **because** it has a small buzzer for the identification of a specific sensor.





# auxi relay expansion module

product code **KSI2300001.300** - auxi relay PCBA

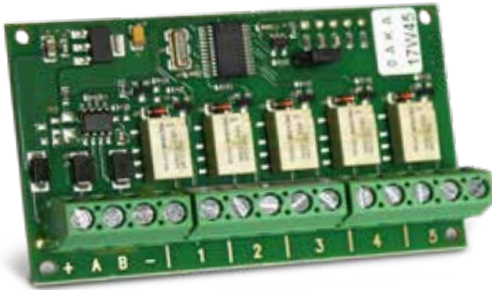

**auxi relay** has 5 relay outputs (1A) which may be used for manage all kind of loads in **lares 4.0** Control Panel series.  
**auxi relay** is programmed directly from **lares 4.0** Control Panel.

## TECHNICAL DATA

- Voltage: 13,8Vdc
- Current consumption: 100mA max.
- Up to 5 relays outputs 1A
- PCBA dimension: 75x45x16 mm (lxhxp)

## HOW TO ORDER

- KSI2300001.300 - auxi relay PCBA

## ACCESSORIES

- KSI7300000.001 - Plastic box for DIN rail
- KSI7302000.010 - Plastic box "slim" version

## PARTS INCLUDED

- 1 auxi-L/ auxi relay expansion module (PCBA)
- 4 sustainers for metal cabinet's mounting
- 1 Installation Manual

## COMPLIANCE

Europe - CE  
EAC

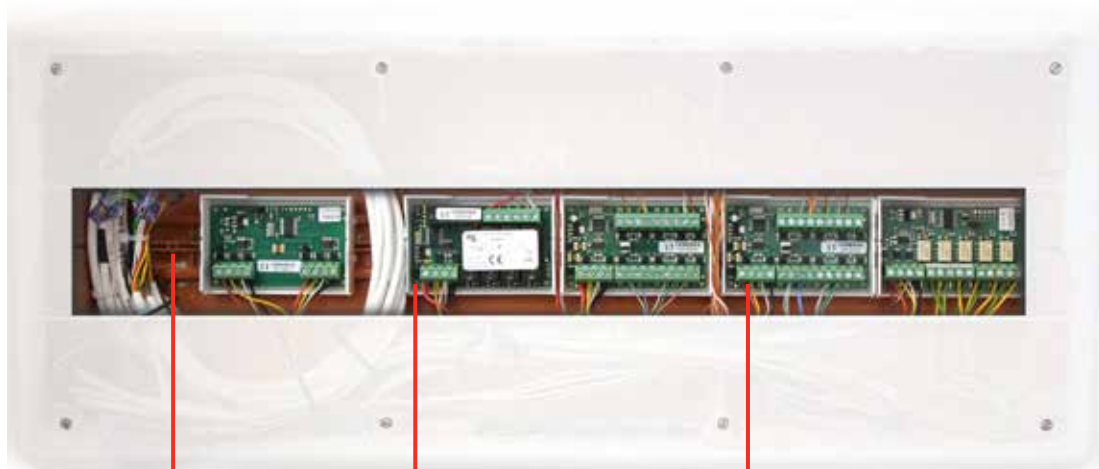

DIN guide

plastic box for DIN guide  
KSI7300000.001

Installed BUS peripherals



# divide BUS Isolator & Repeater

product code **KSI2500000.300** - divide

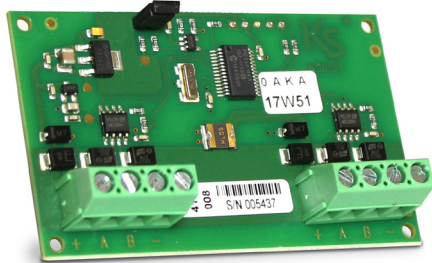

**divide deriva dal latino e significa dividere.**  
**divide derives from Latin and means subdivide.**

**divide BUS Isolator & Repeater is a separation board for the KS-BUS.**

**divide** allows you to separate the KS-BUS in order to dissect a part of the system so that any failure or sabotage of devices will not generate disservice on the whole network; and to boost the signal on the BUS; this amplification allows to increase the extension of the BUS for further 500 m. Due to **divide** characteristics, it is not necessary any kind of programming: thanks to the BUS, the control panel and/or devices continue to “detect” the other parts in a transparent manner.

## BUS Hub module

product code **KSI2500001.300** - BUS Hub PCBA

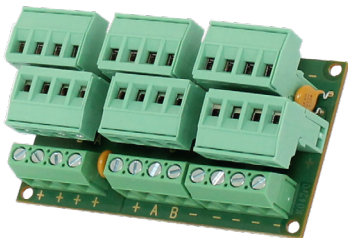

The BUS switch module is a board of extremely compact dimensions, 70x45mm that allows fast wiring and related maintenance operations.

In fact, it connects to the control panel BUS, and has 6 removable terminal boards to which 6 distinct BUS branches can be connected. Each BUS branch has the power supply positive protected with a 0.5A self-resetting thermal fuse.

In addition, there are 4 other terminals for connecting positive power supply (also protected by a 0.5A fuse) and 4 terminals for connecting the negatives.

### TECHNICAL DATA

- Power Supply: 13,8Vdc
- Consumption: 20mA
- KS-BUS terminal: 2 4-wires (specular in connection)
- Board Dimension: 45x75 x16 mm

### PARTS INCLUDED

- 1 Module divide
- 1 Quick Installation Guide
- 4 Plastic sustainers (for installation into “slim” box or metal cabinet)

### HOW TO ORDER

- **KSI2500000.300** - PCBA divide

### ACCESSORIES

- **KSI7300000.001** - Plastic box for DIN rail
- **KSI7302000.010** - Plastic box “slim” version

### CERTIFICATIONS

Europe CE  
EAC  
EN50131 Grade 3 Class II  
T031:2014



### TECHNICAL DATA

- KS-BUS Interface
- PCBA dimension: 75x45x16 mm (lxhxp)

### HOW TO ORDER

- **KSI2500001.300** - BUS HUB module

### PARTS INCLUDED

- 1 BUS Switch (PCBA)
- 4 sustainers for metal cabinet's mounting
- 1 Installation Manual
- 6 Connecting cables

### COMPLIANCE

Europe - CE

# opis Supervised Power Supply Station

Product code **KSI2400000.300** - PCBA only



**opis** deriva dal latino e significa *risorsa, ricchezza, assistenza, appoggio*.  
*opis derives from Latin and means redouble.*

**opis** is a device that allows to extend the BUS on two additional branches. The power supply to the branches it is provided by the same opis, protected by an 1,5 A auto restoring thermal fuse.

The device is fully supervised by the panel, with BUS status, power supply voltage and battery charge information.

**opis** can be installed inside the metal containers KSI7404130.010 and KSI7403130.010.

## TECHNICAL DATA

- **Battery management:** 18 Ah
- **Operating Range:** 14,2 VDC
- **Consumption:** 50 mA stand-by ; 950 mA max
- **Operating temperature range:** -10 +55 °C; 95% Humidity
- **Dimensions:** 115x60x20 mm (PCBA)
- **Weight:** 50 g
- **Maximum current available for external devices:** 1400mA grade 2 - 200mA grade 3

## PARTS INCLUDED

- 1 PCBA opis
- 1 Installation Manual

## HOW TO ORDER

**KSI2400000.300** - PCBA only

## ACCESSORIES

**KSI7403130.010** - Large metallic cabinet with 3.0 A Power Supply

## CERTIFICATIONS

Europe - CE

EAC

EN50131 Grade 3 - Class II

T031:2014

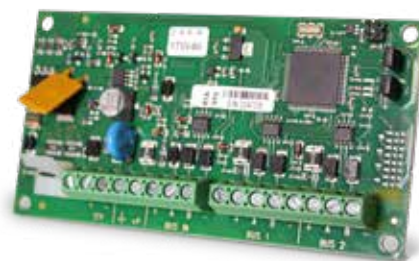

Detail of PCBA

# INDOOR AND OUTDOOR SIRENS



radius.....	84
imago .....	86



DESIGN



COMPACT  
DIMENSIONS



EMERGENCY LIGHT  
FUNCTION



HIGH EFFICIENCY  
LED



TEMPERATURE  
SENSOR



AVAILABLE  
IN DIFFERENT  
COLOURS



EASY TO INSTALL



UV PROTECTION

# radius Indoor siren & Emergency Light

product code **KSI6101000.310** - for KS-BUS only



## TECHNICAL DATA

- Ultra-modern design with additional Emergency Light function
- Acoustic and Lighting signal in case of wire-cutting action
- High Sound Pressure Piezoelectric Buzzer (>100 dBA at 1m)
- **Integrated Temperature Sensor:**  $\pm 0,1^{\circ}\text{C}$
- **Back-up Battery**
- **Temperature Range:** from  $+5^{\circ}$  to  $+40^{\circ}\text{C}$
- **Dimensions (W x H x D):** 102x142x37 mm max
- **Weight (with Battery):** 300 g

## PARTS INCLUDED

- 1 Siren complete with PCBA and battery
- **Set of 4** colored covers
- 1 Quick Installation Guide in ITA/EN

## HOW TO ORDER

**KSI6101000.310** - KS-BUS version

## ACCESSORIES

- **KSI7207008.00** - Lithium-Ion Battery 7,4 Vdc-900 mAh

## CERTIFICATIONS

Europe CE  
EN50131- 4 Grade 3 class II  
T031:2014  
SSF 1014 Larmklass 3

*radius* deriva dal latino e significa **raggio, fascio di luce.**

*radius* derives from Latin and means **ray, radius.**



The **radius** self-powered indoor siren is actually a **professional (acoustic & optical) Sounder** which shows a unique and exclusive design, extremely slim (max. 37 mm thick) associated with a modern technology aimed to combine the best possible performances with the maximum energy saving: very high sound pressure, 3W power LED Alarm Light which also acts as **emergency light in case of main power's black-out**. The siren is fully controlled by a microprocessor which checks the possible status of the device and sends the appropriate signal.

**radius**, like the **ergo** keypads, has been designed to be fully flexible even from a chromatic stand point of view to be easily and superbly integrated in any kind of interior design: as a matter of fact, its design allows the end user to take advantage of 4 different colors, i.e. white, metallized grey, red and black. The battery is steadily monitored and its malfunctioning immediately signalized to the Control Panel. On top of the automatic protection for preventing wire-cutting actions, **radius** is protected by 2 tamper switches against cover opening and against removal from the wall.

In the KS-BUS communication's version (only for lares Control Panels) the siren is equipped with a precision temperature sensor to display the indoor temperature in the **ergo** Ksenia keypads and for Home Automation applications.

## PROGRAMMING

**radius** is linked to the **lares** Control Panel by means of the 4-wires serial KS-BUS and it can be easily programmed from the Control Panel.



1



2

3



4

1. detail of radius colored interchangeable cover.
2. radius with Black lexan cover.
3. Lithium-Ion battery
4. Disassembled

**Perché radius**  
**why radius**

- **because** it has a design that perfectly matches with ergo keypads, with whom it often shares the installed environment.
- **because**, like ergo keyboard, it can be customized in 4 Ksenia colors (white, black, grey and red) simply replacing the internal cover (included in the package).
- **because** it has a high luminous efficiency LED that, in addition to signalling the alarm, can be activated in case of electric blackout and therefore act as an emergency light.
- **because** it has an integrated temperature sensor.
- **because** it can be installed in a few minutes and can be configured quickly, even remotely thanks to KS-BUS connection.



# imago Outdoor siren

product code **KSI6300000.3XX** - Universal  
**KSI6301000.3XX** - for KS-BUS only - in different colors

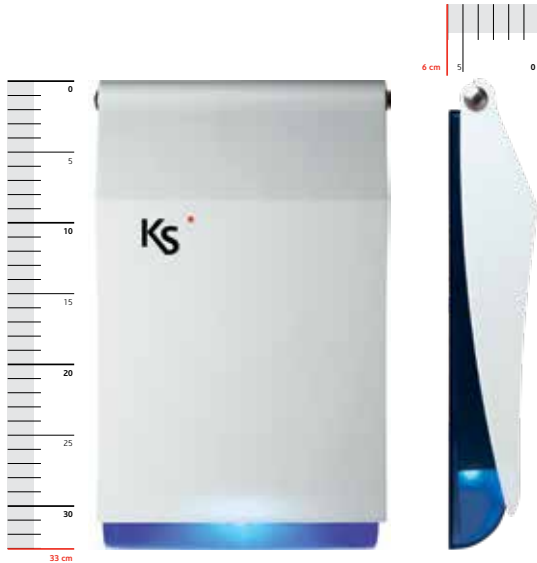

## TECHNICAL DATA

- **Ultra modern design:** with comfortable and original compass opening and a huge range of colour ways
- **Solid Polycarbonate housing:** min. 3 mm thickness, UV-resistant, and available in different chromatic solutions
- **Strong metal undercover against smashing**
- **Transparent bottom:** in orange, red and blue
- **Input for alarm activation** (Universal version only): 1
- **High efficiency 3 LED warnings:** 1 white and 2 red
- **Auto-learning of input polarity**
- **High Sound Pressure Piezoelectric Buzzer:** >100dBa at 1m
- **Alarm Duration's Setting**
- **Tampers Exclusion Programmable:** (Universal version only)
- **Battery Efficiency Control and signalling output:** 500mA OC
- **Protection degree:** IP 43
- **Dimensions:** (W×H×D): 195×330×60 mm
- **Weight:** (without Battery): 1,200 Kg
- **Weight:** (with Battery): 1,500 Kg

## COMPLIANCE

Europe - CE  
EAC (BUS version only)



*imago deriva dal latino e significa aspetto, idea, concetto.  
imago derives from Latin and means aspect, idea, concept.*

imago is connected to the lares 4.0 control panel through the 4-wire serial BUS (KS-BUS) and can be easily programmed from the control panel. Possibility to manage and configure all the siren parameters directly from the web interface.

imago is available in different colors and, on request, can be customized with the Installer logo. The lid can be chosen from 3 color ways: orange, red and blue, and the front side can be selected from the following available colors: white, gray, brown, light-brown, blue and green.

The siren has a minimum thickness of 3mm and this makes it perfectly compatible with any type of installation. It is made with high quality polycarbonate in order to guarantee great resistance over time.

imago is equipped with a sensor that detects and shows the external temperature on the keyboards.

## PROGRAMMING

In the KS-BUS version, imago is linked to the lares Control Panel by means of the 4-wires serial KS-BUS and it can be easily programmed from the Control Panel. In the stand-alone version, imago is equipped with 3 programming Jumpers:

- one for choosing max. Alarm Duration (3 or 10 minutes);
- one for Tampers Exclusion (in case of siren opening, only the tamper relay is activated or even the Alarm functions sound and lights);
- one for Resetting the 3 inputs polarity programming.





Detail of rotating opening and metal undercover

## HOW TO ORDER

Ksenia finished product:

- KSI6300000.3XX\* - Universal
- KSI6301000.3XX\* - KS-BUS version

(\*) The code suffix 3XX indicates the different color option.  
e.g. 318 Is the code for a white cover with red bottom imago.

## AVAILABLE COLOURS

Cover



Transparent background

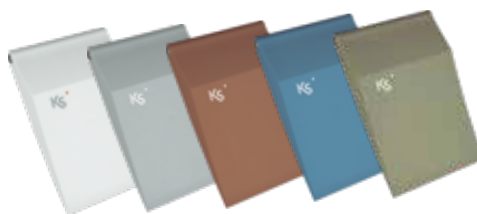

All imago plastic parts are in high-quality thickness Polycarbonate with anti-UV protection and IP43 degree against the worst weather conditions.

Compass Opening for the easiest mounting and installation with strong 6mm inox Steel Bolts.



## WIRED SENSORS AND DETECTORS



unum.....	90
velum .....	92
velum-C .....	93
anti-masking magnetic contact.....	94

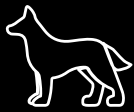

PET IMMUNITY

DT/AM

DUAL TECHNOLOGY  
ANTI MASKING



DESIGN



ANTI MASKING



DETECTION  
RELIABILITY



OUTDOOR  
AND INDOOR  
INSTALLATION



PROTECTION  
OF AREAS



ELT TECHNOLOGY

# unum Indoor Motion Detector

product code **KSI5101000.300** - unum

**KSI5101100.300** - unum Pet Immune

**KSI5102000.300** - unum DT

**KSI5102100.300** - unim DT + Pet immune

**KSI5102010.300** - unum DT + AM

**KSI5102110.300** - unum DT + AM + Pet immune



## TECHNICAL DATA

- **IR Sensor:** Dual-Element-Pyroelectric
- **Power Supply:** 8-16 Vdc; 24 mA at 12 Vdc
- **Alarm Relay:** Solid State, 60V, 50 mA, isolation 1500 Vrms
- **Tamper Switch:** Form A contact, normally closed (NC) 50 mA at 30 Vdc
- **Events Detection:** HighBar false alarm rejection processor
- **RF Immunity:** 20 V/m, 10-1000 MHz; 10 V/m, 1-2 GHz
- **White Light Immunity:** 6500 lux
- **Sensitivity:** Selectable: 2-event or 3-event
- **Operating Temperature Range:** +5°C to +40°C
- **Housing Material:** Base: ABS, Cover: HDPE
- **Overall Dimensions:** 113x60x45 mm (HxWxD)
- **Pet immunity:** up to 10 Kg

## HOW TO ORDER

- **KSI5101000.300** - unum
- **KSI5101100.300** - Pet Immune
- **KSI5102000.300** - unum DT
- **KSI5102100.300** - unim DT + Pet immune
- **KSI5102010.300** - unum DT + AM
- **KSI5102110.300** - unum DT + AM + Pet immune

## ACCESSORIES

- **KSI5900003.000** - Wall-Mounting Bracket

**unum** deriva dal latino e significa **unico**.  
*unum derives from Latin and means unique.*

It can be translated in different appropriate meanings: it incorporates the lens in the front housing, it has the same profile for all technologies (from simple PIR to Dual-Tech) and, for all the above, is unique in the industry.

**Perché unum**  
*why unum*

- **because** they are innovative and professional motion detectors, with a sober and minimalist design, perfectly adaptable to any interior architecture;
- **because** the unsightly ones have disappeared outside the sensors "Colored lights" - leds - which are very annoying for customers endings;
- **because** the different detector models all have the same dimensions, despite having different functional characteristics, are they infrared or dual technology, with immunity from animals domestic or not;
- **because** they have a wide range of operating temperatures;
- **because**, in compliance with the Ksenia Security philosophy, unum sensors they use components such as DSP ASICs with energy consumption very small.



\* only codes **KSI5102000.300** e **KSI5102100.300**



\* only codes **KSI5102000.300**, **KSI5102100.300**, **KSI5102010.300** e **KSI5102110.300**,

**Range**

12 meters in sensor-facing direction  
 12 meters at 45° angle from sensor-facing direction

**Optical Fields-of-View**

**Long-range:** 44  
**Mid-range:** 36  
**Short-range:** 18

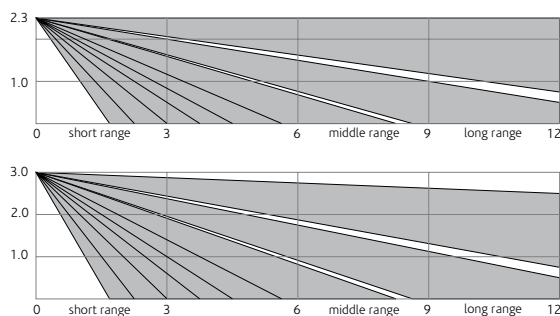

Sensor Optical View Pattern: side view, in meters

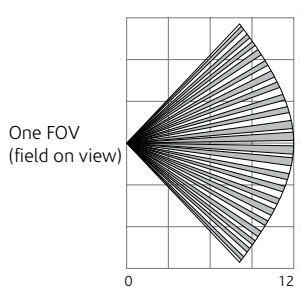

Sensor Optical View Pattern (top view, in meters)

**DUAL TECHNOLOGY**

DT unum include two motion sensing technology: microwave Doppler motion sensing and PIR motion sensing.

The microwave technology includes a modern, compact, DRO-based micro-strip Doppler transceiver, with PCB “patch” antennas. Constant-motion signals (such as fans) are deemphasized, and fluorescent light frequencies are digitally removed.

The DT-PI unum motion detectors join the advantages of the Dual-Technology and Pet Immunity.

**PET IMMUNITY**

The PI-PIR Motion Detector unum is designed to allow the presence of pets (10 kg or lighter) without signaling an alarm. It includes a special micro-element lens array that produces much stronger optical signals for humans than for pets. Furthermore, the optical sensitivity of each PI-PIR Motion Detectors unum is factory-calibrated to ensure accurate discrimination between humans and pets.

The diagram below shows those zones of greatest human/pet discrimination by the PI-PIR Motion Detector unum, it should be mounted so that pets will occupy only the lighter-colored spaces.

**OPERATION OF ANTI-MASKING**

The mask is detected by two analysis, running simultaneously: the first is an alteration of normal balance between alarm signals from Infrared (PIR) and microwave derived from the analysis continuous signal, using a reduced sensitivity of the microwave to minimize the effect of continuously moving objects that could affect only the microwave. You can disable this type of analysis acting on a jumper.

The second analysis is based on an area of supervision (within one meters from the sensor): a person entering in the safe zone will activate the detection process of masking. This second function cannot be disabled.

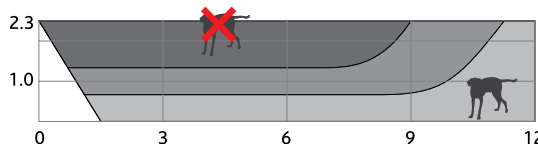

# velum DT AM Outdoor Curtain Motion Detector

product code **KSI5302010.303 - velum DT AM**



## TECHNICAL DATA

- **Power Supply:** standard 12V, max 13,4V
- **IR range:** 12m (room temperature 25 ° C)
- **Operating Frequency:** MW: 24.125GHz
- **Range MW:** 12m
- **Antimasking Analysis:** active infrared LED
- **Thornproof:** mems platform. (Accelerometer)
- **Sabotage:** front microswitch
- **Operating Temperature Range:** from -20°C to +55° C
- **Range MW:** adjustable by trimmer
- **Analysis control tear:** enabling by dip-switch
- **Analysis antimasking:** enabling by dip-switch
- **LED indicators:** RGB in five colors, can be disabled via dip-switch
- **Detection area:** only a tent (angle 7.5 °) **Horizontal coverage:** IR 90°, 80° MW, **Vertical coverage:** IR 7.5°, 32° MW
- **Amplitude tent:** at 2m 25cm, 130cm at 10m
- **Detection range:** from 0.30m to 12m
- **Installation height:** 2.30m from 2.10m max on the wall
- **Material and color (housing and clamps):** ABS gray
- **Dimension:** 38 x 129 x 40mm (l x h x p)
- **Weight:** 90g
- **Protection:** IP54
- **Embedded EOL resistance:** triple balancing 10Kohm parallel (To enable via microswitch) integrated on the pcb

## HOW TO ORDER

**KSI5302010.303 - velum DT AM**

## ACCESSORIES

- **KSI5900003.003 - Rain protection**

*velum* deriva dal latino e significa *velo*.  
*velum* derives from Latin and means *veil*.

Ksenia velum is a motion sensor dual technology with Anti masking which can be installed both outside and inside.

It may simply mean that the sensor projects a dual Technology barrier shielding (infrared and microwave) which completely fills the area to be protected by covering it evenly, precisely as with a veil.

## FUNCTIONS

velum detectors are motion sensors made with advanced professional components and materials among the best in the world. From every point of view, these sensors guarantee the highest degree of reliability in the detection of the movement, without incurring false alarms.

The motion detector velum includes two technologies for motion



detection: microwave doppler effect and infrared. Together, these two signals are interpreted by proprietary algorithms that reject false alarms and detect unwanted intrusions.

Section microwave sensors velum includes a modern and compact tranceuver doppler microscstrip. The Doppler signal is digitally processed to obtain the highest degree of reliability in intrusion detection and exclusion problems. The signals of repetitive motion are filtered so as frequencies

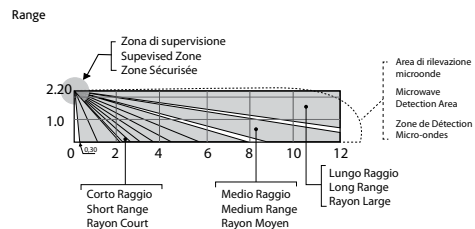
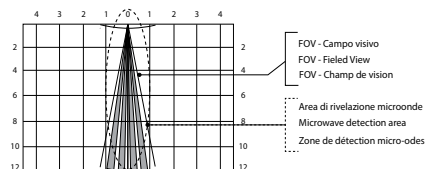

Diagram of visual coverage



# velum-C Outdoor Curtain Motion Detector

product code **KSI5302011.303 - velum-C**



## TECHNICAL DATA

- Range: 6 m (room temperature 25°C)
- IR sensor: Dual element
- Operating frequency uW: 24.125 GHz
- ANTIMASKING Analysis: active infrared LED
- Thornproof: Accelerometer
- Sabotage: front microswitch
- Operating temperature range: from -20°C to +55° C
- RFI/EMI immunity: 20 V/m, 10-1000 MHz; 10 V/m, 1-2 Ghz
- White light immunity: 6500 lux
- Sight range: up to 300 m
- Detection area: only a tent (angle from 7,5°)
- Vertical coverage: IR 90°, MW 80°
- Installation height: from 2 to 6 m on the wall
- Material housing and clamps: ABS
- Dimension: 129 x 38 x 40 mm
- Weigh: 90 g
- Protection: IP 54
- Color: gray

## HOW TO ORDER

- KSI5302011.303 - velum-C

resulting from fluorescent light are eliminated in digitally. The section to the IR acts with a lens combined with an infrared detector of high quality. Finally, the signal is evaluated by a processor, for obtaining the exclusion of false alarms while maintaining an excellent degree of intrusion detection. The masking of the lens of the infrared analysis is carried out using infrared LED active, able to detect any obstacle placed in the vicinity of the lens.

velum detectors are the ideal solution ideal solution to protect canopies, porches, below balcony, windows etc. The sensor velum is synonymous reliability and high safety, not only from the qualitative point of view, but also against sabotage attempts, given that integrates a station with accelerometer flexible and functional even in installations with the hub and a micro switch for front opening.

velum-C detector is a curtain motion detector that has the same main characteristics as velum wls detector; it can however be installed on the ceiling with a 6m vertical flow.

In this way, positioned at the center of the frame, it ensures its complete coverage, creating an insurmountable barrier to any intruder.

## Perché velum why velum

- **because** the different detector models, all have the same design and the same size, while having different characteristics, whether wired or wireless technology. This avoids the typical "drop style" resulting from seeing often objects of different shape on the walls, maybe even the same room or local.
- **because** they guarantee maximum reliability when installed inside and outside in all weather conditions.
- **because** inside of the small size contains the latest technology in terms of environmental detection by integrating a dual technology.

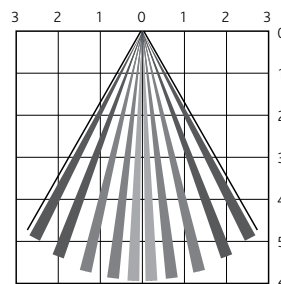

# ANTI-MASKING MAGNETIC CONTACTS

product code **KSI5CLR-TW.0TX** - anti-masking built-in magnetic contact (brown and white)  
**KSI5CLS-TW.2CX** - anti-masking magnetic contact (brown and white)  
**KSI5CLH111.000** - anti-masking to view magnetic contact  
**KSI5CLV-02.00X** - inertial magnetic contact

**AM Sensor built-in**  
 KSI5CLR-TW.0TX

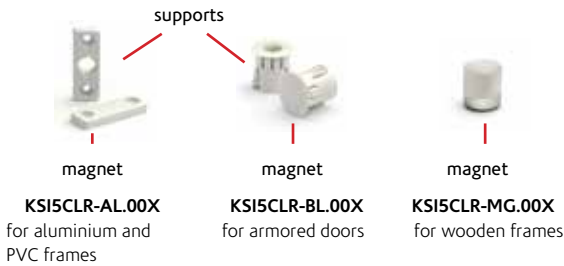

**Sensor built-in**

- **KSI5CLR-TW.0TN** - Brown
- **KSI5CLR-TW.0TW** - White

Integrated parallel double balanced, anti-masking, connection with 2 screw terminals, ideal for: wooden frames (with KSI5CLR-MG00N/W), aluminum frames/PVC (with KSI5CLR-AL.00N/W), armored doors (with KSI5CLR-BL.00N/W), MAGNET EXCLUDED.

Adapter frames (aluminum / PVC)

- **KSI5CLR-AL.00N** - Brown
- **KSI5CLR-AL.00W** - White

Magnet and adapter on surface for aluminum frames or PVC.

Adapter for armored doors

- **KSI5CLR-BL.00N** - Brown
- **KSI5CLR-BL.00W** - White

Built-in Magnet and adapter for armored doors.

Magnetic sensor

- **KSI5CLR-MG.00N** - Brown
- **KSI5CLR-MG.00W** - White

Built-in Magnet and adapter for wooden frames.

## FUNCTIONS

The Magnetic contacts traditional, technology-based Reed, are easily vulnerable.

It is in fact simple masking the absence of the magnet abutment on a Reed contact, which means opening of the door, with the application of a magnet from the outside of the gate also to the alarm is armed, and having then access undisturbed.

In high security applications, the solution was up to now the use of sensors to "triple balancing magnetic", albeit with a considerable burden in terms of costs and installation time dimensions.

Ksenia Security offers a solution to the problem: stop the reed contacts.

The Magnasphere® Technology contact Ksenia, even in the smallest flush model, offers a high-performance Security comparable with those obtained from contacts in triple balancing magnetic.

## MAIN DATA

- Designed with patented Magnasphere® technology
- Protective and insulating treatment of the PCB (conformal coating) with resin
- Double parallel balancing with 2 resistors 10 KΩ integrate
- Absence of constraints for positioning
- Individual quality control

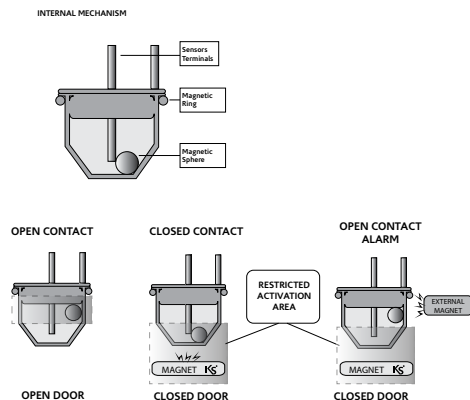



**AM Sensor to view**  
KSI5CLS-TW.2CX



**AM Sensor to view**  
KSI5CLH111.000



**AM Sensor to view**  
KSI5CLV-02.00X



**Inertial sensor to view**

- KSI5CLS-TW.2CN - Brown
- KSI5CLS-TW.2CW - White

Integrated parallel double balanced, anti-masking, 2-pole cable connection, 200cm cable length MAGNET EXCLUDED.

**AM to view magnetic contact**

- KSI5CLH111.000

with Stainless Steel Cable of 50 cm, with 200cm cable. Ideal for Commercial/Industrial applications.

**AM to view magnetic contact**

- KSI5CLV-02.00X

Completely resinated and with a nylon case reinforced by glass fiber. They are ideal also for outdoor use.

**FUNCTIONS**

Ksenia inertial sensors are the first in the world based on **Magnasphere®** magnetic technology for vibration detection. Based on a new hybrid inertial / magnetic principle, the inertials are not subject to positioning constraints and can therefore be installed in areas where the risk of burglary is higher. At the same time they guarantee a long operating life, free from false alarms. Their sensitivity is comparable to that of the best sensors available on the market today. Completely resinated and with a fiberglass reinforced nylon case, they are also ideal for outdoor use.

**MAIN DATA**

- Designed with patented Magnasphere® technology
- Protective and insulating treatment of the PCB (conformal coating) with resin.
- Efficiency, prolonged in time
- Absence of constraints for positioning
- individual quality control

# VIDEO VERIFICATION AND VIDEO-ANALYSIS SYSTEM



Mini Bullet.....	98
Mini Dome.....	99
NVR.....	100



PUSH  
NOTIFICATIONS



NETWORK IP



IMAGE RECORDING

**IP67**

OUTDOOR  
PROTECTION

# IR Mini Bullet IP Camera

product code **KSV0010140.300** - Mini Bullet IP camera

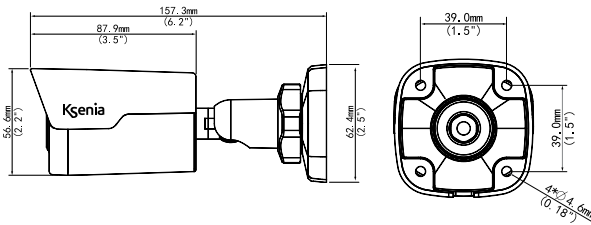

Mini Bullet junction box

## FUNCTIONS DESCRIPTION

Mini Bullet is an IP video-surveillance camera for outdoor / indoor use with 4 MP CMOS sensor in HD with IP67 protection grade and day / night functionality, smart IR, IR distance up to 30m, optical glass lens with higher light transmission, anti-reflective IR lens which increases the transmittance of the infrared 3D DNR (Digital Noise Reduction) H.265, H.264, MJPEG Video format 9:16 IP67 in compliance with ONVIF protocol.

## PROGRAMMING

KSV cameras are fully programmable via web interface

## IP camera Onvif Protocol

The Ksenia cameras, implements the Onvif protocol, an important industry standardization of IP video, a result of a collaboration between the major industry manufacturers. With this protocol a camera KSV can be integrated into any recording software IP or NVR.

## TECHNICAL DATA

- Sensor: 1/3", 4.0 Mpx, progressive scan, CMOS
- Lens: 3.6mm @ F1.8
- Angle of view (H): 87°
- Shutter: Auto/Manual, 1/6 ~ 1/8000 s
- Min. Illumination Colour: 0.02 Lux (F1.8, AGC ON)  
0 Lux with IR on
- Day/Night: IR-cut filter with auto switch (ICR)
- IR Range: Up to 30m (98 ft) IR range
- S/N: >55dB
- WDR: 120dB
- Noise Reduction: 2D/3D

## Video

- Max. Resolution: 2592 × 1520
- Video Compression: H.265/H.264/MJPEG
- Frame Rate: 4MP (2592×1520): Max. 20 fps;  
4MP (2560×1440): Max. 25 fps;  
3MP (2048×1520): Max. 30 fps;  
1080P (1920×1080): Max. 30 fps
- Video Streaming: Triple
- ROI: Supported
- OSD: Up to 8 OSDs
- Motion Detection: Up to 2 areas
- Privacy Mask: Up to 4 areas

## Network

- Protocols: L2TP, IPv4, IGMP, ICMP, ARP, TCP, UDP, DHCP, PPPoE, RTP, RTSP, DNS, DDNS, NTP, FTP, UPnP, HTTP, HTTPS, SMTP, SNMP, SIP, QoS
- Compatible, Integration: ONVIF, API

## Interface:

- Network 1 RJ45 10M/100M Base-TX Ethernet

## General

- Power: 12 V DC, or PoE (IEEE802.3 af)
- Power consumption: Max 6.4 W
- Dimensions: (L × W × H) 157.3 × 62.4 × 63 mm
- Weight: 0.45 kg (0.99 lb)
- Working Environment:  
-35° C ~ +60° C (-31° F ~ 140° F)
- Humidity 95% RH (non-condensing)
- Ingress Protection IP67

## INCLUDED PARTS

- 4 MP IR Bullet Camera IP
- CD (Installaton Manual + software)
- Connector Cover for external Ethernet plug

## HOW TO ORDER

- **KSV0010140.300** - IP camera Mini Bullet
- **KSV0030001.000** - Mini Bullet junction box

# IR Mini Dome IP Camera

product code **KSV0013120.300** - Mini Dome IP camera



Mini Dome junction box

## FUNCTIONS DESCRIPTION

Mini Dome is an IP video-surveillance camera for indoor / outdoor use with progressive 1 / 2.8 "CMOS sensor, 2MP with 25Fps, mechanical ICR, 3.6mm fixed optics  $f2.0$ , brightness 0.01Lux  $f2.0$  (0 with Led ON), IR LED range up to 20mt, 1 LAN 10 / 100Mbps, privacy mask 4 areas, 3D, WDR (120db) basic video analysis, face detection, 12Vdc power supply or PoE <5W and IP66 environmental protection degree, Dimensions  $\varnothing110 \times 61$ mm ( $\varnothing4.3 \times 2.4$ ")

## PROGRAMMING

KSV cameras are fully programmable via web interface

## IP camera Onvif Protocol

The Ksenia cameras, implements the Onvif protocol, an important industry standardization of IP video, a result of a collaboration between the major industry manufacturers. With this protocol a camera KSV can be integrated into any recording software IP or NVR.

## TECHNICAL DATA

- **Sensor:** 1/2.8", 2.0 Mpx, progressive scan, CMOS
- **Lens:** 2.8mm
- **Angle of view (H):** 115°
- **Shutter:** Auto/Manual, 1/6 ~ 1/8000 s
- **Min. Illumination Colour:** 0.02 Lux (F2.0, AGC ON)  
0 Lux with IR on
- **Day/Night:** IR-cut filter with auto switch (ICR)
- **IR Range:** Up to 30m (98 ft) IR range
- **S/N:** >52dB

## Video

- **Max. Resolution:** 1920 × 1080
- **Video Compression:** H.265/MJPEG
- **Frame Rate:**
  - 1080P (1920 × 1080): Max. 30 fps; 720P (1280 × 720): Max. 30 fps;
  - D1 (720 × 576): Max. 25 fps
- **Video Streaming:** Triple
- **ROI:** Supported
- **OSD:** Up to 8 OSDs
- **Privacy Mask:** Up to 4 areas

## Storage

- **Edge Storage:** Micro SD, Up to 128 GB

## Network

- **Protocols:** L2TP, IPv4, IGMP, ICMP, ARP, TCP, UDP, DHCP, PPPoE, RTP, RTSP, DNS, DDNS, NTP, FTP, UPnP, HTTP, HTTPS, SMTP,SNMP, SIP, QoS
- **Compatible, Integration:** ONVIF, API

## Interface:

- **Audio I/O:** audio cable
  - Input: impedance 35 k $\Omega$ ; amplitude 2 V [p-p]
  - Output: impedance 600  $\Omega$ ; amplitude 2 V [p-p]
- **Built-in Mic:** supported
- **Network:** 10M/100M Base-TX Ethernet

## General

- **Power:** 12 V DC, or PoE (IEEE 802.3 af)
- **Power consumption:** 3~5W
- **Dimensions:**  $\varnothing110 \times 61$  mm ( $\varnothing4.3 \times 2.4$ ")
- **Weight:** 0.25 kg (0.55 lb)
- **Working Environment:**
  - 35° C ~ +60° C (-31° F ~ 140° F)
- **Humidity:** 95% RH (non-condensing)
- **Ingress Protection:** IP66

## INCLUDED PARTS

- 2 MP IR Mini Dome Camera IP
- CD (Installaton Manual + software)
- Connector Cover for external Ethernet plug

## HOW TO ORDER

- **KSV0013120.300** - Mini Dome IP camera
- **KSV0030002.000** - Mini Dome junction box

# Ksenia NVR

## Network Video Recorder

product code **KSV0021082.300 - NVR**



### FUNCTIONS DESCRIPTION

Ksenia NVR is a device that can capture and record images and video streams from IP cameras. It can manage up to a maximum of 8 IP cameras, has two video outputs, one HDMI and one VGA. It also has 4 inputs and 2 alarm outputs. On the device it is necessary to put a hard disk (not supplied) with SATA interface with a maximum capacity of 6TB.

#### IP camera Onvif Protocol

The Ksenia cameras, implements the Onvif protocol, an important industry standardization of IP video, a result of a collaboration between the major industry manufacturers. With this protocol a camera KSV can be integrated into any recording software IP or NVR.

### TECHNICAL DATA

#### VIDEO AND AUDIO

**IP Video Input:** 8-ch  
**Two-way audio Input:** 1-ch, RCA

#### NETWORK

**Incoming bandwidth:** 60Mbps  
**Outgoing bandwidth:** 64Mbps  
**Remote connection:** 128

#### VIDEO/AUDIO OUTPUT

**HDMI Output:** 4K (3840 × 2160)/30Hz,  
1920 × 1080p/60Hz, 1920 × 1080p/50Hz,  
1600 × 1200/60Hz, 1280 × 1024/60Hz,  
1280 × 720/60Hz, 1024 × 768/60Hz

**VGA Output:** 1920 × 1080p/60Hz,  
1920 × 1080p/50Hz, 1600 × 1200/60Hz,  
1280 × 1024/60Hz, 1280 × 720/60Hz,  
1024 × 768/60Hz

**Audio Output:** 1-ch, RCA

**Recording Resolution:** 12MP/8MP/6MP/5MP/4MP/3MP/1080p/960p/720p/D1/2CIF/CIF

**Synchronous Playback:** 8-ch

#### DECODING

- **Compression:** H.265/H.264
- **Live view/Playback:** 12MP/8MP/6MP/5MP/4MP/3MP/1080p/960p/720p/D1/2CIF/CIF
- **Capability:** 1 × 12MP @ 20, 1 × 4K @ 30,  
3 × 4MP @ 20, 4 × 1080p @ 25,  
8 × 720p @ 25, 16 × D1

#### HARD DISK

- **SATA:** 1 SATA interface
- **Capacity:** up to 6TB for each disk

#### EXTERNAL INTERFACE

- **Network Interface:** 1 RJ-45 10M/100M self-adaptive Ethernet Interface
- **Network Function:** HTTP, TCP/IP, IPV4, UPNP, RTSP, UDP, SMTP, NTP, DHCP, DNS, IP Filter, PPPoE, DDNS, FTP, IP Server, P2P
- **USB Interface:** Rear panel: 2 × USB2.0, Front panel: 1 × USB2.0
- **Alarm In:** 4-ch
- **Alarm Out:** 1-ch

#### GENERAL

- **Power Supply:** 12 Vdc
- **Consumption ( without HDD ):** 8 W
- **Working Temperature:** -10° C ~ + 55° C  
( +14° F ~ +131° F )
- **Working Humidity:** 10% ~ 90%
- **Dimensions:** 44 × 260 × 240mm  
( 1.7" × 10.2" × 9.4" )
- **Weight ( without HDD ):** 1.12 Kg ( 2.47 lb )

#### HOW TO ORDER

- **KSV0021082.300 - NVR**



**SMART HOME  
BUILDING MANAGEMENT SYSTEM**

## SERVICES FOR INSTALLERS



Ksenia PRO APP.....	104
Talent LMS.....	105
Ksenia SecureWeb.....	106
Automatic Back up.....	107
Configuration Web Server.....	108
Ksenia DNS.....	110
vigilo .....	111





ONLY FOR  
PROFESSIONAL  
INSTALLERS



MULTI-PLATFORM



WEBSERVER  
PROGRAMMING



APP  
PROGRAMMING

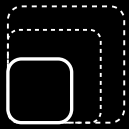

UNIQUE  
PLATFORM



SECURE  
SERVICE



BASED ON AWS



TRAINING  
PLATFORM

# Ksenia Pro App: only for Professional Installer



The IoT (Internet-of-Things) Platforms represent a significant advancement in their Value Proposition also thanks to the Ksenia SecureWeb. Ksenia SecureWeb, in fact, offers to the Installer a single dedicated APP named KSENIA PRO, which allows the Control Panel Configuration from any mobile terminal, smart-phone included, simply by scanning the Control Panel QR-code and the registration with geolocalization.

Furthermore, with this fantastic Tool, the Installer has the possibility to receive all the Technical Release, Marketing News, Reserved Commercial information and any variation applied to the Installer Manuals.

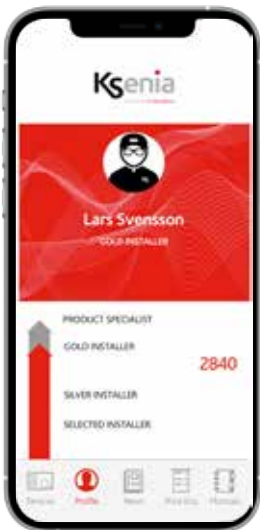

# Talent LMS: only for professional Ksenia Installers

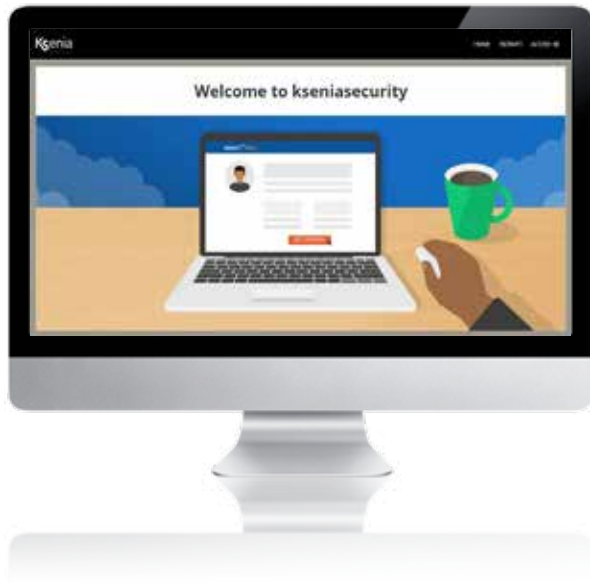

**Selected  
Installer**



**Silver  
Installer**



**Gold  
Installer**



**Specialist  
Installer**

Technical Training plays a key role on the basis of Ksenia Security solutions; just think that every year we hold on average more than 120 training courses in Italy and abroad, reserved to Professional Security Installers and our Distributor technicians and Sales staff.

For this reason, we wanted to grow and make this service even more widespread and useful, by introducing a new e-learning system that will complete the training activity that we have been carrying out and that we are still carrying on.

Thus, we launched a new platform called LMS (Learning Management System) available on <http://kseniasecurity.talentlms.com> link, allowing registered Installers to access several educational contents regarding the most technical aspects of our products, especially related to the lars 4.0 system.

The Ksenia Security Installer Certification Program also reports updates, evolving on the same platform.

In fact, upon completion of specific modules, Ksenia installers can have an online certification exam which, if successful, gives the opportunity to join the Loyalty Program, providing visibility on our website [www.kseniasecurity.com](http://www.kseniasecurity.com), reserved area. This generates free advertising for all those who will show interest in our solutions.

The Ksenia Security Certification Program has been completely redesigned and includes 4 Certification categories, according to the following settlement:

- Selected Installer
- Silver Certified Installer
- Gold Certified Installer
- Specialist Certified Installer

This is an educational path; therefore, it always starts from the first step (Selected Installer) and then progresses towards the next Certification levels.

The Certificates acquired are valid for a whole calendar year; to renew them, it will be enough to score the minimum required in the Loyalty Program.

# Ksenia SecureWeb: new interface, new functions, new world



The technological evolution of Ksenia Security is always in continuous expansion. Ksenia SecureWeb platform is the proof, characterized by a strong innovative implementation, thanks to the latest improvements made. SecureWeb, the secure Cloud that allows the development of complex applications, has taken a leap forward that by far anticipates the near

future, gaining a leading position in the world of Business Intelligence. Its graphic interface has been improved, simplifying the organization of the data, through an unprecedented dynamism; greater fluidity has been conferred to the Installer dashboard and the speed of unloading has increased significantly. It offers to Installer valuable tools to have full control of your profile, accessing the certification

level with simplicity and transparency. It guarantees the highest level of Security and respect for Privacy in terms of accessibility, network encryption and DRP (Disaster Recovery Plan). Therefore, Ksenia SecureWeb is able to make the best use of all the resources to realize really competitive strategies, offering processing power, data base storage, orderly distribution of contents and all the other features that support the sizing and growth of different needs, both for the End User and for the Installer.

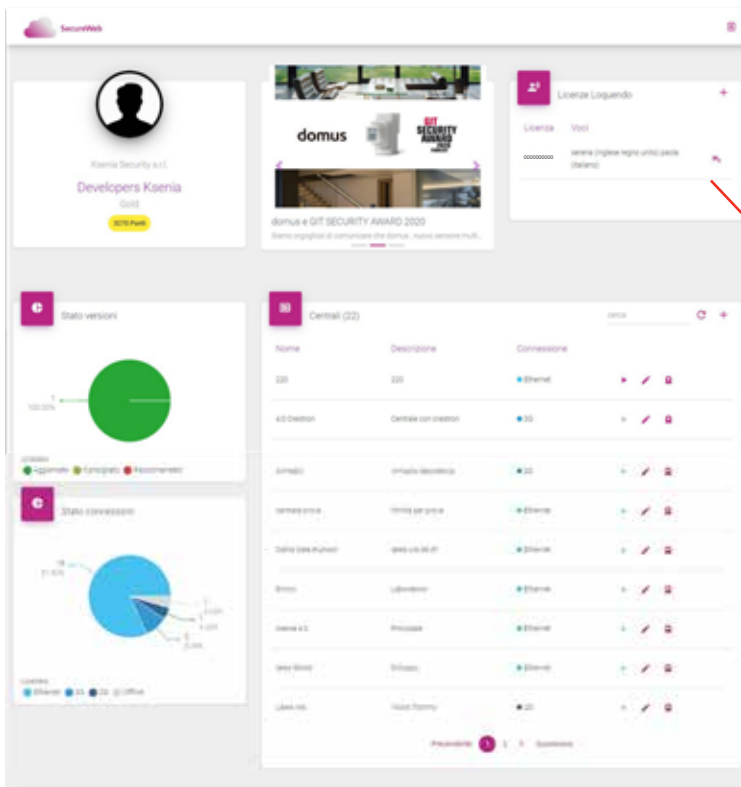

Thanks to Loquendo scratch card (p/n KSI7800011.000) and using Ksenia Pro it is possible to generate voice messages with text-to-speech (TTS) synthesis, in the chosen voice and language, without the need to be in the system, like the license provided on a USB key requires instead.

# AUTOMATIC BACKUP

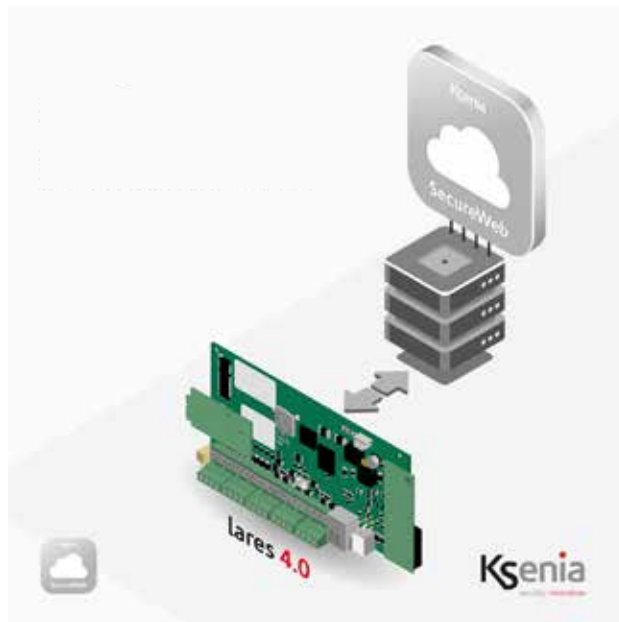

The automatic backup is one of the online free of charge services offered by Ksenia Security. Its activation is important in order not to lose any system information and when necessary, recover it with a simple click.

The service gives automatic copies of the system configuration data, with the possibility of restoring if necessary, both on the same control panel and on different control panels.

The maximum number of automatic saves is 3 for each system and, when the limit is reached, the oldest backup copies will be overwritten. A maximum of 2 copies can be preserved from overwriting by adding a specific description to identify them. A copy, however, will always be overwriteable.

After the first activation, the automatic backup will be always operative and available for the installer via local connection or through Ksenia SecureWeb connection. On the other hand, the page where it is possible to view backups, lock files with a description and restore the configuration, is only visible by starting the Installer from Ksenia SecureWeb. The backup file with configuration data and graphic map images, is saved locally and then uploaded to the cloud. In case of unavailability of the connection, the control panel carries out all the necessary attempts until the upload is complete.

The automatic backup service is offered as a free trial until June 30, 2021. At the end of the trial period, if you decide to renew it, you can choose between different subscription plans according to your needs.

All the other already existing SecureWeb services and lares 4.0 and Ksenia PRO Applications, will remain FREE of charge.

## Perché backup automatico why automatic backup

- **because** it gives the opportunity to automatically save copies of the system configuration data, including graphic maps images;
- **because** nothing will be lost: everything can be quickly recovered with just one click;
- **because** it gives the opportunity to restore a configuration both on the same control panel and on different control panels;
- **because** it allows a considerable time saving and guarantees the maximum reliability and safety of the saved data.

# Web Server for Installers

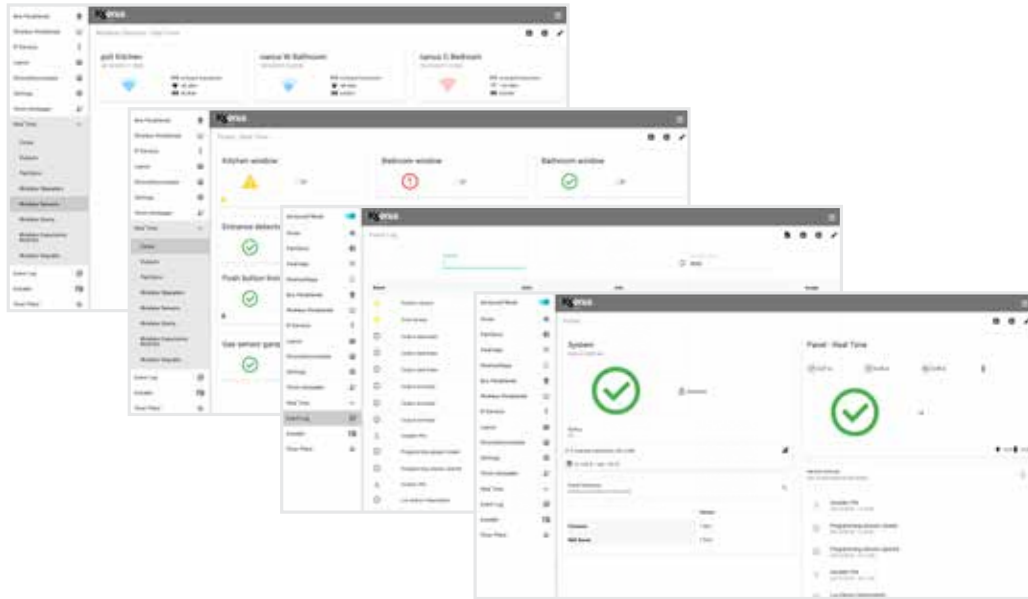

With the lares 4.0 platform, Ksenia has revolutionized the way of programming and maintaining the Security and Home & Building Automation systems.

In fact, for these operations it is no longer necessary to use a software installed on the installer's PC, but it is sufficient to connect to the control panel's web server, which contains the programming interface. This operation is made even simpler and faster thanks to the use of the Ksenia Secureweb platform that allows you to reach the control panel, even remotely, via a cloud based on AWS with the most advanced data encryption systems.

The installer has several ways to connect with lares 4.0 systems:

- **In local connection**

Via any web browser, simply by entering the local IP address of the lares 4.0 control panel.

- **APP "Ksenia Pro"**

By downloading the dedicated APP for Security installers for free and scanning the control panel's QR code.

- **Ksenia Secureweb**

Through any browser, by accessing the page [www.kseniasecureweb.com](http://www.kseniasecureweb.com)

The configuration interface is modern, intuitive and extremely fast.

It allows to reduce connection times and eliminates the possibility of making errors due to data synchronization failure, since, following the connection, the real system configuration will be shown directly without any need to explicitly download data before making changes. Simultaneous access by several technicians is also allowed to check the configuration, the status of the system and the possible presence of faults.

The increase in speed is a visible plus even after sending a new configuration that no longer requires a system restart and thus avoids long waiting times and the annoying reset of the active outputs during this operation.

A further and fundamental aspect to consider is its universality. The user interface and the installer interface that are used to manage and program this new generation of control panels are always the same, for systems ranging from residential to small, medium and large industrial, and for wired, wireless or hybrids.

It is constantly enriched and simplified to provide a faster and more complete user experience through semi-automatic updates managed independently by the lares 4.0.

Finally, the very simple adaptation to the various languages by the whole system should be emphasized.

The control panel language is quickly set by the installer during the start-up phase of the control panel, while the user APP and installer interface languages automatically adapt to the language used by the smartphone and the web browser.

# Web Server Ksenia

the revolution in programming and maintaining  
Security and Home & building Automation systems





# DNS

## Gratuito / Free

All the service is completely free for all Ksenia customers; no deadline in terms of time or computational resources.

## Assistenza / Tech. Support

All users can access the e-mail support to resolve configuration issues or to our Ksenia support.



## DNS Dinamico / Dynamic DNS

The dyndns is a tool to update in real time a URL, making it always point to the IP address of your system. In this way, the IP address can even change, but the URL address remains the same over time, allowing the connection to the line with dynamic IP address.

KseniaDns.com is a free service without paying options that can exploit this mechanism to your dynamic IP, associating a fixed URL. Inserting a device Ksenia configured to use the DDNS service, in your network, you can indirectly also access other resources, such as cameras, NVR, etc.

## SMTP gratuito / free SMTP

Even if the dyndns service is not necessary in the case of control panel management via SecureWeb, registering the control panels to the service, it provides a free SMTP server that Ksenia devices can use to send emails.

## Semplice da usare / Simple to use

Simplified configuration for all Ksenia devices, using the software basis in three steps: register on the portal (only the first time), register a personal URL, by registering URL configuration of basis / lares 4.0.

## www.kseniadns.com

A free service to Ksenia Selected Installers.

## Professionale / Professional

All recordings are used to manage countless clients / devices from your account, and you can also monitor all their interactions with the server devices ksenia ddns in the log. Finally you can make advanced searches using various types of filtering information.

## Dettagliato / Documented

The service is provided by a very detailed online help for both the registration process and the operation of the various devices.

## Performante e Reattivo / Effective and Reactive

A service-based cluster of redundant servers provided directly by Telecom Italy, unlimited resources to provide an efficient, responsive h24 Service.

Kseniadns.com, as all Ksenia solutions, simple unique.





# vigilo Alarm Receiving and Centralization Software

Product code **KSI7810500.001** - vigilo-pro software



## TECHNICAL DATA

- **CPU:** Intel® Braswell Dual-Core Celeron N3000 Processor
- **RAM:** 2 GB Up to 8 GB DDR3L at 1600MHz
- **Hard Disk:** 64 GB M.2 SSD
- **Graphic:** Intel® HD Graphics
- **LAN:** 10/100/1000/Gigabits Mbps
- **Wireless:** 802.11 b/g/n, Bluetooth V4.0
- **I/O:** 2 x USB 3.0, 1 x Kensington Lock, 1 D-sub or 1 MiniDP, 1 x HDMI Port, 1 x RJ45 LAN, 2 x USB 3.1 Gen 1 Port, 1 x DC-in, 1 x Audio Jack (Mic in/Headphone out)
- **Power:** 45 W Power Adapter
- **Dimensions:** 13,1 x 13,1 x 4,2 cm (h x l x p)

## HOW TO ORDER

- **KSI7810500.001** - vigilo-pro software - up to 500 systems

## OPTIONALS

- **KSI7810000.000** - Online service contract for one year (after the first)
- **KSI7810000.100** - Ticket for each technical assistance out of contract

## COMPLIANCE

Europe - RoHS, CE

**vigilo is the Alarm Receiving and Centralizing software by Ksenia Security.**

Thanks to the enormous opportunities offered by their lares IP panels, directly connected to the network without need of additional transmission devices, or to the gemino GSM/GPRS Communicator, the next logical step offered by Ksenia is to allow, for example, Headquarters of a Credit Institute to centralize a very significant number of systems as well as to allow selected Ksenia installers to offer new and important services to their customers (for example tele-service and tele-maintenance). vigilo provides three levels of access (installer, operator, user) and does not require any application: just open an internet browser and connect to the IP address of the panel on which it is installed to display the system status. It also works with all operating systems including Android tablet or MAC OS.

The vigilo SW (not to be confused with the CMS-Central Monitoring Station SW) it is designed to be very simple, effective and still able to receive any events from systems connected to it. The number of such systems can reach up to 500 in "vigilo pro" version (professional).

Basically, it is organized into three sections:

- **alert:** section dedicated only to those events programmed to be of priority such as alarms.
- **events:** section dedicated to receiving all events, even technical
- **maps:** all systems connected to the SW are geo-localized on Google Maps to visualize them and enable the installer to define the most convenient itinerary depending on the intervention priority.

Both SW versions are preferably supplied on an industrial compact size PC, already pre-loaded, tested and protected in order to present to the installer a Plug&Play kit. This requires only to be powered and linked to the IP to give immediate access to the network of IP platforms lares.

SW and HW supports are warranted and included in the price for a period of one year starting from the purchasing date.

# FULL INSTALLATION

## Legenda

- KS-BUS 485
- Universal
- RS-232
- PoE / LAN
- LAN
- Wireless

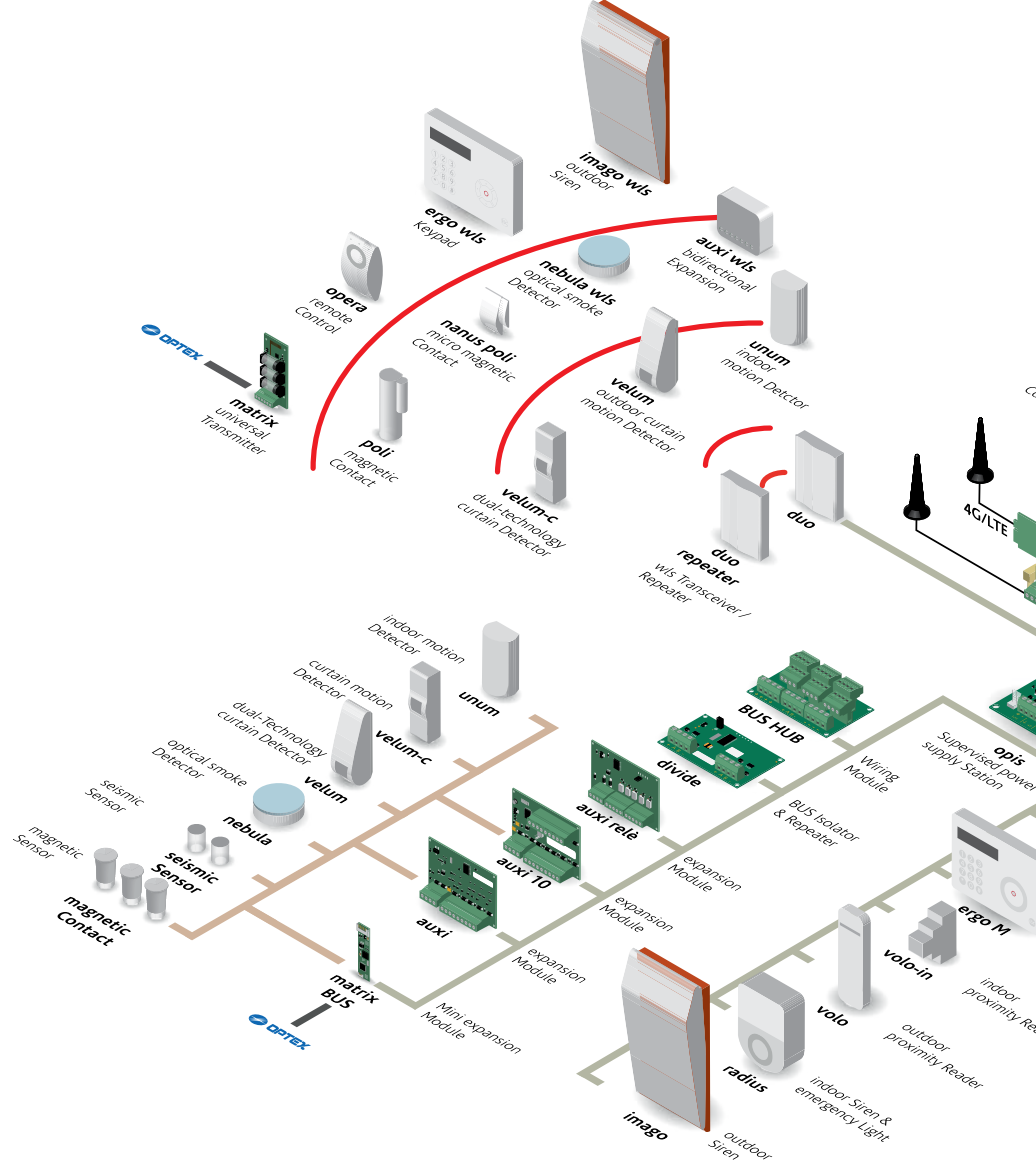

# CON CHART

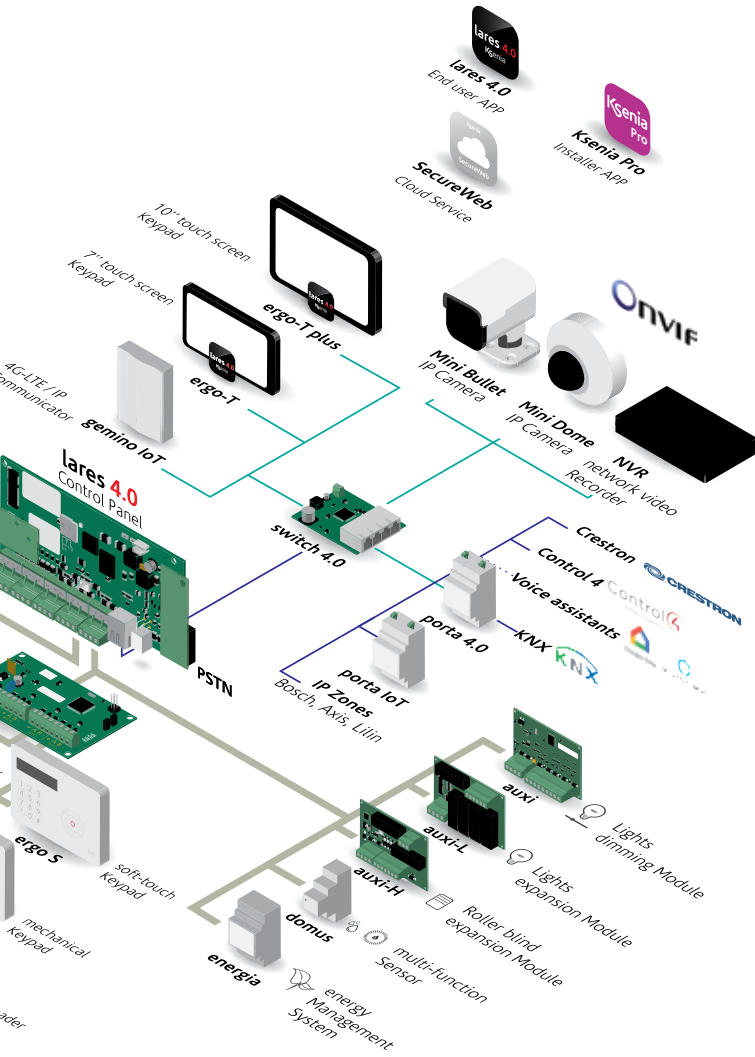

The data shown in this printout are purely indicative. Ksenia Security reserves the right to make any changes to the products deemed necessary.





**Ksenia Security Srl**  
Strada Provinciale Valtesino,49  
63065 Ripatransone, AP, Italy  
tel. +39 0735 751646 / fax +39 0735 652281



**General Informations** / [info@kseniasecurity.com](mailto:info@kseniasecurity.com)  
**Sales** / [sales@kseniasecurity.com](mailto:sales@kseniasecurity.com)  
**Technical Support** / [helpdesk@kseniasecurity.com](mailto:helpdesk@kseniasecurity.com)

